

PALLET RACKING SYSTEMS

2020
2021

Extract from general catalog

[ssi-schaefer.com](https://www.ssi-schaefer.com)

Chapter D



SSI SCHÄFER

Pallet racking – a modular system with limitless versatility

SSI SCHAEFER's pallet racking systems are so handy as the Euro and Industrial pallets themselves. It doesn't matter what kind of load carrier – pallets, mesh boxes or any other – longitudinal beam racks for single- or multiple place storage ensure high mobility of ware and quick goods turnover. Multi-place longitudinal beam rack systems are used in diverse branches from wholesale or spare parts warehouses in the electronics, mechanics and automotive industries.

Single-place rack systems are ideal for storing goods with the same base carrier and varying heights. Drive-in rack systems have proven their value especially when storing a very large quantity of a limited range of articles.

Using adequate accessories, pallets and containers, even with varying sizes, this kind of rack system enables optimal storage.



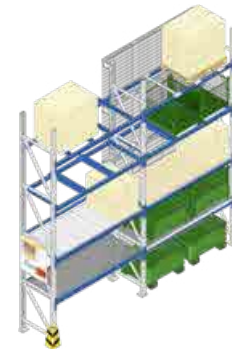

PR 350 longitudinal beam racking page **D4**



PR 600 longitudinal beam racking page **D8**

Accessories for pallet racking page **D12**

Safety accessories page **D16**

Storage and storage space labeling page **D20**

PR 600 front-to-back beam racking page **D24**

Drive-in and drive-through racking page **D26**

Mobile racking page **D28**

Pallet live storage racking page **D30**

High rise racking page **D32**

Boxes /
containers

Modular
shelving

Longspan
racking

Pallet
racking

Cantilever
racking

Mezzanines /
platforms

On-line shelving /
KDR shelving

Semi-automated
solutions

Logistics
systems

Appendix



Overview of pallet racking systems

	Longitudinal beam rackings PR 350	Longitudinal beam rackings PR 600
Areas of use	Pallet storage of medium and high-volume goods with medium to high loads, e.g. in production areas and for on-line shelving	Pallet storage of medium and high-volume goods with medium to high loads, e.g. for logistics services or in distribution warehouses
Advantages	<ul style="list-style-type: none"> ▶ Solid and robust construction ▶ Easy assembly with only a few components 	<ul style="list-style-type: none"> ▶ Light and economical ▶ Sturdy due to special design ▶ Highest dimensional accuracy
Design	▶ Welded frame construction with longitudinal beams, 3 types of upright profiles each with 3 frame depths, 10 frame heights, 2 beam profile types, 7 bay widths	▶ Bolted frame construction with longitudinal beams, 4 stand profiles each with 3 frame depths, 10 frame heights, 2 beam types, 7 bay width
Beam connection	▶ Bolt-free system	▶ Bolt-free system
System hole pattern	▶ 50 : 50 mm	▶ 50 : 50 mm
Upright profile widths	▶ 70, 80, 100 mm	▶ 75, 90, 100, 120 mm
Frame load capacity	▶ Up to 12,500 kg	▶ Up to 30,000 kg
Beam load capacity	▶ Up to 4,500 kg per pair	▶ Up to 4,500 kg per pair
Frame surface	▶ Painted RAL 7037, Dust Gray	▶ Galvanized
Beam surface	▶ Painted RAL 5010, Gentian Blue	▶ Painted RAL 5010, Gentian Blue



D4



D8

from pages

i **Safety equipment for racks according to German regulation DG-UV 108-007**

- 1.1 Row end frame height increase**
by at least 500 mm above the top rack height
- 1.2 Passage overhead protection**
These must be covered by chipboard, grating or similar.
Clear passage height must be at least minimum 2,000 mm
- 1.3 Safety distance between load carriers**
Safety distance between load carriers lower than 100 mm?
Back stops will be necessary inside double-sided racks
- 1.4 End Frames**
Corner protectors must be installed at all free-standing end frames.
This also applies to passages
- 1.5 Single-sided rack rows**
If one side of a free-standing single-row rack is not used for loading or unloading, this side must be secured, preventing ware units from falling out. For example using nets, solid or mesh back panels
- 1.6 Transposed storage**
If the skids or feet of load carriers are parallel to beams, or not directly supported by beams, they must be secured by front-to-back supports, chipboards, mesh grates or similar devices
- 1.7 Load signs**
These must be provided for all rack installations

i **Technical regulations for the pallet racking**

- 2.1 Rack rows**
A rack row must consist of at least 3 rack bays
- 2.2 Beam levels**
There must be at least 2 beam levels per rack bay
- 2.3 Compartment heights**
The compartment heights must not differ by more than 200 mm.
The maximum compartment height is 2,500 mm
- 2.4 Concrete quality of the hall floor**
Minimum concrete quality of the hall floor:
C20/25 as per EN 1992. Concrete thickness 200 mm

i Information regarding **inspection requirements**
for rack systems

Chapter J, page J1



PR 350 pallet racking

Longitudinal beam racks can be used universally for all tasks in the warehouse. Using adequate accessories, pallets and containers, even with varying sizes, this kind of rack system enables optimal storage.

The PR 350 longitudinal beam rack is the development of the robust and solid rack technology and represents the continuity at SSI SCHAEFER. This modular storage system has been in use and thoroughly proven its qualities for more than 15 years.

The compatibility to other systems and the high range of accessories allow the continuous expansion of existing equipment and rack solutions.



Frames and longitudinal beams PR 350

DUST GRAY



Frame

RAL 7037

GENTIAN BLUE



Longitudinal beams

RAL 5010

- ▶ **High load capacity**
Frame load capacity of up to 12,500 kg (for min. 2 beam pairs INP 100 per rack bay and 5 rack bays per rack row), beam load capacity up to 4,500 kg per pair
- ▶ **Sturdy due to special design**
- ▶ **High-quality materials**
- ▶ **System hole pattern**
with adjustment spacing 50 : 50 mm
- ▶ **Support widths**
70, 80, 100 mm
- ▶ **Easy assembly**
with only a few components
- ▶ **Welded frame construction**
- ▶ **Solid base**
- ▶ **Robust design**
with a material thicknesses up to 4 mm

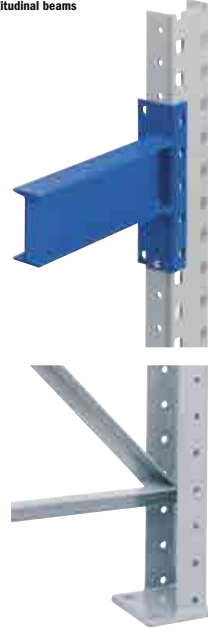

Front-to-back supports
Page D14

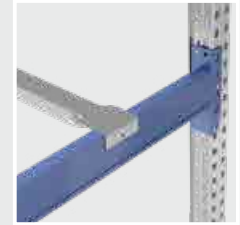

Front-to-back supports

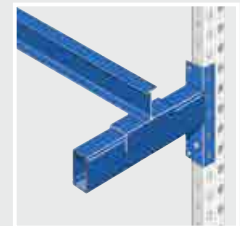

Fork spacer

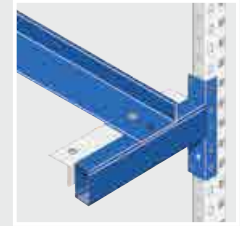

Front-to-back supports made of angled profile with locking bracket

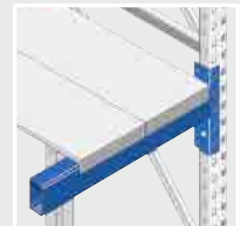

Steel panels, attached

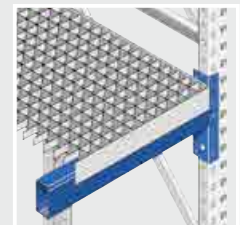

Mesh panels, attached



Chipboard with edge protection, attached

Mesh back panels
Page D18

Frame
Page D6

Fork spacers
Page D14

Front-to-back support from the angled profile
Page D14

Steel panels on INP beam profile
Page D15

Load sign
Page D19

Chipboards attached
Page D16

Mesh panels on beam profile INP
Page D15

Corner protector
Page D16

Longitudinal beams
Page D7



Corner protector



Load sign

Boxes / containers

Modular shelving

Longspan racking

Pallet racking

Cantilever racking

Mezzanines / platforms

On-line shelving / KDR shelving

Semi-automated solutions

Logistics systems

Appendix



PR 350 frame

► Frame load capacity

The permissible load capacity of the frame depends on the compartment height and the planned beam profile. The specified values apply for racks with at least 2 pairs of longitudinal beams/rack bays, rows with at least 5 rack bays and INP 100 beam profiles. The values vary depending on the beam profile.

If you have any questions please contact our technical consultants.

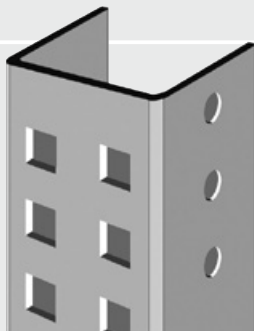
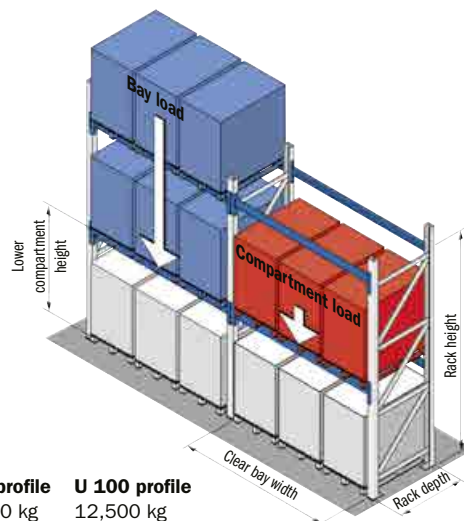

Compartment height	Frame load capacity		
	U 70 profile	U 80 profile	U 100 profile
1,000 mm	5,500 kg	10,600 kg	12,500 kg
1,250 mm	5,200 kg	10,000 kg	12,000 kg
1,500 mm	4,600 kg	9,600 kg	11,800 kg
1,750 mm	4,000 kg	9,300 kg	11,600 kg
2,000 mm	3,650 kg	8,000 kg	10,000 kg
2,250 mm	3,300 kg	7,200 kg	9,000 kg
2,500 mm	2,900 kg	6,000 kg	7,500 kg

Catalog dimensions

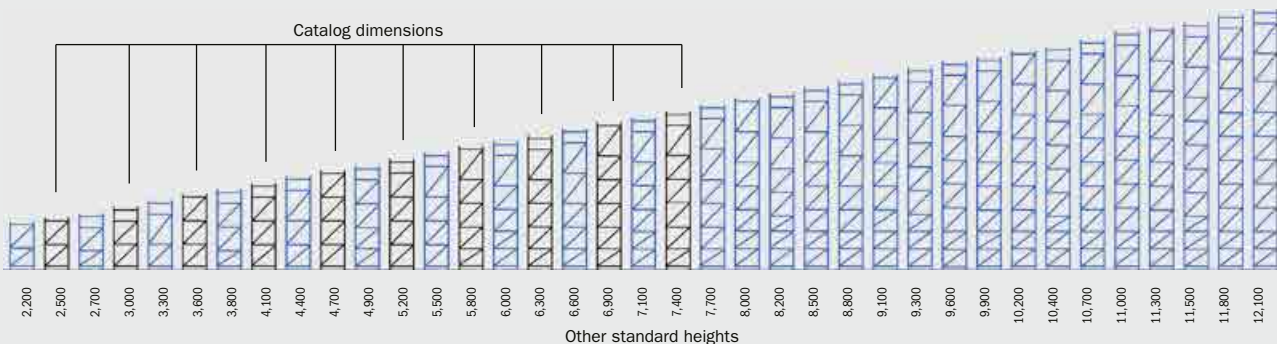

Other standard heights

Item	Frame height (mm)	Frame depth (mm)	Order no.	Item	Frame height (mm)	Frame depth (mm)	Order no.	Item	Frame height (mm)	Frame depth (mm)	Order no.
U 70 profile											
RN 70258	2,500	850	126030	RN 70251	2,500	1,050	126390	RN 70252	2,500	1,250	126750
RN 70308	3,000	850	126090	RN 70301	3,000	1,050	126450	RN 70302	3,000	1,250	126810
RN 70368	3,600	850	126150	RN 70361	3,600	1,050	126510	RN 70362	3,600	1,250	126870
RN 70418	4,100	850	126210	RN 70411	4,100	1,050	126570	RN 70412	4,100	1,250	126930
RN 70478	4,700	850	126270	RN 70471	4,700	1,050	126630	RN 70472	4,700	1,250	126990
RN 70528	5,200	850	126330	RN 70521	5,200	1,050	126690	RN 70522	5,200	1,250	127050
U 80 profile											
RN 80258	2,500	850	126040	RN 80251	2,500	1,050	126400	RN 80252	2,500	1,250	126760
RN 80308	3,000	850	126100	RN 80301	3,000	1,050	126460	RN 80302	3,000	1,250	126820
RN 80368	3,600	850	126160	RN 80361	3,600	1,050	126520	RN 80362	3,600	1,250	126880
RN 80418	4,100	850	126220	RN 80411	4,100	1,050	126580	RN 80412	4,100	1,250	126940
RN 80478	4,700	850	126280	RN 80471	4,700	1,050	126640	RN 80472	4,700	1,250	127000
RN 80528	5,200	850	126340	RN 80521	5,200	1,050	126700	RN 80522	5,200	1,250	127060
RN 80588	5,800	850	127120	RN 80581	5,800	1,050	127480	RN 80582	5,800	1,250	127840
RN 80638	6,300	850	127180	RN 80631	6,300	1,050	127540	RN 80632	6,300	1,250	127900
RN 80698	6,900	850	127240	RN 80691	6,900	1,050	127600	RN 80692	6,900	1,250	127960
RN 80748	7,400	850	127300	RN 80741	7,400	1,050	127660	RN 80742	7,400	1,250	128020
U 100 profile											
RN 10368	3,600	850	126170	RN 10361	3,600	1,050	126530	RN 10362	3,600	1,250	126890
RN 10418	4,100	850	126230	RN 10411	4,100	1,050	126590	RN 10412	4,100	1,250	126950
RN 10478	4,700	850	126290	RN 10471	4,700	1,050	126650	RN 10472	4,700	1,250	127010
RN 10528	5,200	850	126350	RN 10521	5,200	1,050	126710	RN 10522	5,200	1,250	127070
RN 10588	5,800	850	127130	RN 10581	5,800	1,050	127490	RN 10582	5,800	1,250	127850
RN 10638	6,300	850	127190	RN 10631	6,300	1,050	127550	RN 10632	6,300	1,250	127910
RN 10698	6,900	850	127250	RN 10691	6,900	1,050	127610	RN 10692	6,900	1,250	127970
RN 10748	7,400	850	127310	RN 10741	7,400	1,050	127670	RN 10742	7,400	1,250	128030

Order no. = on stock

DUST GRAY

Support profiles



RAL 7037

GENTIAN BLUE

Longitudinal beams



RAL 5010

Longitudinal beams

► Support profiles

made from thick-walled U-profile. Welded together with horizontal and diagonal braces to create a stable frame.

System hole pattern 50 : 50 mm steps.

Solid floor plates safely transfer the loads to the floor.

► Longitudinal beams

with welded 5-hook rear lips. These guarantee an interlocking connection with the rack supports.

Adjustable using the system hole pattern 50 : 50 mm.

2 retaining pins (included in the scope of delivery) per section are required to prevent unintentional removal.

The load specifications apply for uniformly distributed loads.

The order numbers apply for one beam.

► Longitudinal beam rack system dimensions

Storage in depth direction

Pallet dimensions	Insertion depth	Rack depth
800 x 1,200 mm	1,200 mm	1,050 mm
1,000 x 1,200 mm	1,200 mm	1,050 mm
1,200 x 1,200 mm	1,200 mm	1,050 mm

Storage in transverse direction

Pallet dimensions	Insertion depth	Rack depth
800 x 1,200 mm	800 mm	850 mm
1,000 x 1,200 mm	1,000 mm	1,050 mm

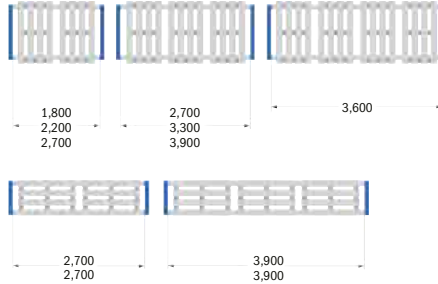

PR 350 accessories

from page **D14**

Longitudinal beams with INP profile

Item	Load/ pair (kg)	Profile type	Order no.	Item	Load/ pair (kg)	Profile type	Order no.	Item	Load/ pair (kg)	Profile type	Order no.
Length 1,800 mm				Length 2,200 mm				Length 2,700 mm			
TRN1-180-08-I	3,000	INP 80	323560	TRN1-220-08-I	2,500	INP 80	323600	TRN1-270-08-I	2,100	INP 80	323650
TRN1-180-10-I	4,500	INP 100	323720	TRN1-220-10-I	4,200	INP 100	323760	TRN1-270-10-I	3,500	INP 100	323810
								TRN1-270-12-I	4,500	INP 120	324030
Length 2,900 mm				Length 3,300 mm							
TRN1-290-08-I	1,900	INP 80	323670	TRN1-330-08-I	1,400	INP 80	323710				
TRN1-290-10-I	3,300	INP 100	323830	TRN1-330-10-I	2,700	INP 100	323870				
TRN1-290-12-I	4,500	INP 120	324050	TRN1-330-12-I	4,400	INP 120	324090				
Length 3,600 mm				Length 3,900 mm							
TRN1-360-10-I	2,300	INP 100	323900	TRN1-390-10-I	2,000	INP 100	323930				
TRN1-360-12-I	3,900	INP 120	324120	TRN1-390-12-I	3,400	INP 120	324150				

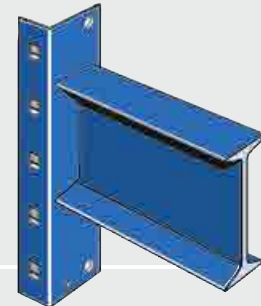

Longitudinal beams with CE profile

Item	Load/ pair (kg)	Profile type	Order no.	Item	Load/ pair (kg)	Profile type	Order no.	Item	Load/ pair (kg)	Profile type	Order no.
Length 1,800 mm				Length 2,200 mm				Length 2,700 mm			
TRN1-180-085-30 CE	3,200	CE 80	324220	TRN1-220-085-30 CE	2,500	CE 80	324230	TRN1-270-085-30 CE	1,700	CE 80	324240
TRN1-180-105-30 CE	4,200	CE 100	on req.	TRN1-220-105-30 CE	3,500	CE 100	on req.*	TRN1-270-105-30 CE	2,600	CE 100	on req.*
TRN1-180-115-30 CE	4,500	CE 110	324300	TRN1-220-115-30 CE	3,900	CE 110	324310	TRN1-270-115-30 CE	3,000	CE 110	324320
								TRN1-270-125-30 CE	3,600	CE 120	on req.*
								TRN1-270-145-30 CE	4,300	CE 140	312850
Length 2,900 mm				Length 3,300 mm							
TRN1-290-085-30 CE	1,500	CE 80	on req.*	TRN1-330-115-30 CE	2,200	CE 110	324340				
TRN1-290-105-30 CE	2,300	CE 100	on req.*	TRN1-330-125-30 CE	2,600	CE 120	on req.*				
TRN1-290-115-30 CE	2,700	CE 110	324330	TRN1-330-145-30 CE	3,100	CE 140	312910				
TRN1-290-125-30 CE	3,200	CE 120	on req.*								
TRN1-290-145-30 CE	3,800	CE 140	312870								
Length 3,600 mm				Length 3,900 mm							
TRN1-360-115-30 CE	1,900	CE 110	324350	TRN1-390-145-30 CE	2,300	CE 140	312970				
TRN1-360-125-30 CE	2,300	CE 120	on req.*								
TRN1-360-145-30 CE	2,700	CE 140	312940								

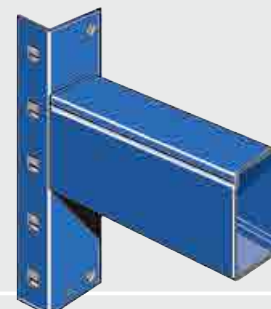

* Minimum order quantity on request.

Boxes /
containersModular
shelvingLongspan
rackingPallet
rackingCantilever
rackingMezzanines /
platformsOn-line shelving /
KDR shelvingSemi-automated
solutionsLogistics
systems

Appendix

PR 600 – the modern pallet racking system

The PR 600 rack system is characterized by its diverse, versatile configuration options. This enables the implementation of all designs including longitudinal beams, front-to-back beams and drive-in racking systems for maximum storage capacity with a minimum volume.

One advantage that frequently does not come into play until later is the

ability to adapt the system to changing circumstances. The rack frames are bolted together and also designed for the highest loads.

This is a modern pallet racking system – a versatile stacking system for individual solutions.

► **Tested quality**

PR 600 longitudinal beam racks have the RAL-RG 614/2 seal of quality. Compliance with the criteria is checked twice per year by an independent authority. This guarantees that both the material and the production fulfill the high quality requirements.



GALVANIZED



Frame

GENTIAN BLUE



Longitudinal beams

RAL 5010

- ▶ **High load capacity**
Frame load capacity of up to 30,000 kg (for min. 2 beam pairs INP 100 per rack bay and 5 rack bays per rack row), beam load capacity up to 4,500 kg per pair
- ▶ **Light and economical**
- ▶ **Sturdy due to special design**
- ▶ **High-quality materials**
- ▶ **Precise dimensional accuracy**
- ▶ **System hole pattern**
with adjustment spacing 50 : 50 mm
- ▶ **Support widths**
75, 90, 100, 120 mm
- ▶ **Easy assembly**
with only a few components
- ▶ **Bolted frame construction**



Frames and longitudinal beams PR 600

Front-to-back supports

Page D14

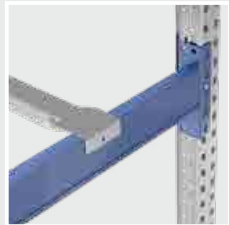

Front-to-back supports

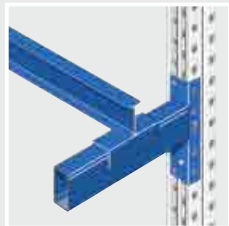

Fork spacer

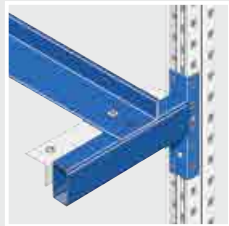

Front-to-back supports made of angled profile with locking bracket



Steel panels, attached

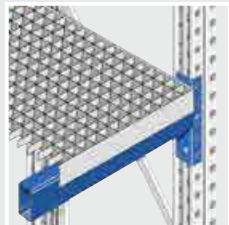

Mesh panels, attached

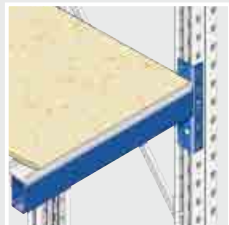

Chipboard with edge protection, attached

Mesh back panels

Page D18

Frame

Page D10

Front-to-back support from the angled profile

Page D14

End stops

Page D19

Fork spacers

Page D14

Load sign

Page D19

Steel panels on INP beam profile

Page D15

Chipboards attached

Page D16

Mesh panels on beam profile INP

Page D15

Corner protector

Page D16

Longitudinal beams

Page D11



Corner protector



Load sign

Boxes / containers

Modular shelving

Longspan racking

Pallet racking

Cantilever racking

Mezzanines / platforms

On-line shelving / KDR shelving

Semi-automated solutions

Logistics systems

Appendix

PR 600 frame

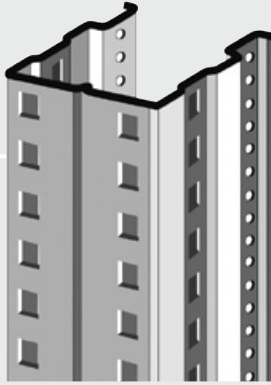

► Frame load capacity

The permissible bay load capacity of the frame depends on the compartment height and the planned beam profile. The specified values apply for racks with at least 2 pairs of longitudinal beams/rack bay, rows with at least 5 rack bays and CE 110 for bays width 2,700 mm along with CE 140 for bay with 3,600 mm). The values vary depending on the beam profile.

Compartment heights exceeding 2,500 mm require a separate static calculation.

If you have any questions please contact our technical consultants.

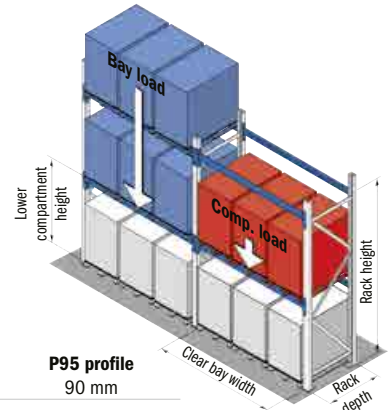

Support width	P73 profile 75 mm		P93 profile 90 mm		P95 profile 90 mm	
	Frame load capacity					
	Bay width		Bay width		Bay width	
Comp. height	2,700 mm	3,600 mm	2,700 mm	3,600 mm	2,700 mm	3,600 mm
750 mm	9,050 kg	7,850 kg	10,400 kg	9,450 kg	16,300 kg	16,750 kg
1,000 mm	9,050 kg	7,850 kg	9,850 kg	9,150 kg	13,350 kg	13,400 kg
1,250 mm	7,200 kg	6,900 kg	9,250 kg	8,500 kg	12,700 kg	11,700 kg
1,500 mm	7,100 kg	6,800 kg	9,250 kg	8,500 kg	12,600 kg	11,350 kg
1,750 mm	6,850 kg	6,700 kg	8,900 kg	8,300 kg	10,700 kg	10,400 kg
2,000 mm	6,850 kg	6,700 kg	8,750 kg	8,150 kg	10,700 kg	10,400 kg
2,250 mm	6,550 kg	6,450 kg	8,750 kg	8,100 kg	10,050 kg	9,950 kg
2,500 mm	5,700 kg	5,700 kg	7,450 kg	7,750 kg	10,050 kg	9,750 kg

Other frame profiles

on request

PR 600 accessories

from page D12

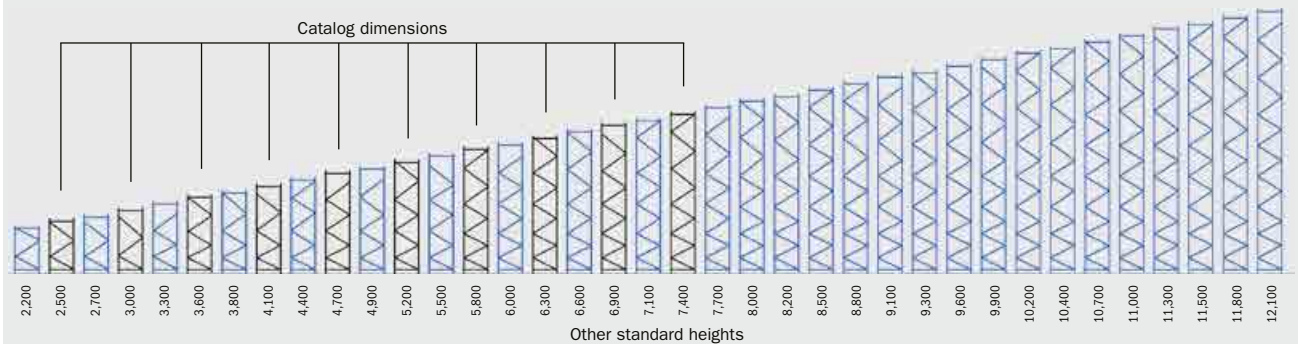

P 73 profile

Item	Frame height (mm)	Order no.	Item	Frame height (mm)	Order no.	Item	Frame height (mm)	Order no.
Frame depth 850 mm			Frame depth 1,050 mm			Frame depth 1,250 mm		
RV1-773-0250-085	2,500	307280	RV1-773-0250-105	2,500	307520	RV1-773-0250-125	2,500	307760
RV1-773-0300-085	3,000	307290	RV1-773-0300-105	3,000	307530	RV1-773-0300-125	3,000	307770
RV1-773-0360-085	3,600	307300	RV1-773-0360-105	3,600	307540	RV1-773-0360-125	3,600	307780
RV1-773-0410-085	4,100	307310	RV1-773-0410-105	4,100	307550	RV1-773-0410-125	4,100	307790
RV1-773-0470-085	4,700	307320	RV1-773-0470-105	4,700	307560	RV1-773-0470-125	4,700	307800
RV1-773-0520-085	5,200	307330	RV1-773-0520-105	5,200	307570	RV1-773-0520-125	5,200	307810

P 93 profile

RV1-973-0250-085	2,500	307340	RV1-973-0250-105	2,500	307580	RV1-973-0250-125	2,500	307820
RV1-973-0300-085	3,000	307350	RV1-973-0300-105	3,000	307590	RV1-973-0300-125	3,000	307830
RV1-973-0360-085	3,600	307360	RV1-973-0360-105	3,600	307600	RV1-973-0360-125	3,600	307840
RV1-973-0410-085	4,100	307370	RV1-973-0410-105	4,100	307610	RV1-973-0410-125	4,100	307850
RV1-973-0470-085	4,700	307380	RV1-973-0470-105	4,700	307620	RV1-973-0470-125	4,700	307860
RV1-973-0520-085	5,200	307390	RV1-973-0520-105	5,200	307630	RV1-973-0520-125	5,200	307870
RV1-973-0580-085	5,800	307400	RV1-973-0580-105	5,800	307640	RV1-973-0580-125	5,800	307880
RV1-973-0630-085	6,300	307410	RV1-973-0630-105	6,300	307650	RV1-973-0630-125	6,300	307890
RV1-973-0690-085	6,900	307420	RV1-973-0690-105	6,900	307660	RV1-973-0690-125	6,900	307900
RV1-973-0740-085	7,400	307430	RV1-973-0740-105	7,400	307670	RV1-973-0740-125	7,400	307910

P 95 profile

RV1-975-0360-085	3,600	307440	RV1-975-0360-105	3,600	307680	RV1-975-0360-125	3,600	307920
RV1-975-0410-085	4,100	307450	RV1-975-0410-105	4,100	307690	RV1-975-0410-125	4,100	307930
RV1-975-0470-085	4,700	307460	RV1-975-0470-105	4,700	307700	RV1-975-0470-125	4,700	307940
RV1-975-0520-085	5,200	307470	RV1-975-0520-105	5,200	307710	RV1-975-0520-125	5,200	307950
RV1-975-0580-085	5,800	307480	RV1-975-0580-105	5,800	307720	RV1-975-0580-125	5,800	307960
RV1-975-0630-085	6,300	307490	RV1-975-0630-105	6,300	307730	RV1-975-0630-125	6,300	307970
RV1-975-0690-085	6,900	307500	RV1-975-0690-105	6,900	307740	RV1-975-0690-125	6,900	307980
RV1-975-0740-085	7,400	307510	RV1-975-0740-105	7,400	307750	RV1-975-0740-125	7,400	307990

Order no. = on stock



Support profiles



Longitudinal beams

RAL 5010

► **Support profiles**

Made of cold rolled, high-strength steel. Their special shape makes the supports highly rigid. These are bolted together with horizontal and diagonal braces to create a sturdy frame. Delivered unassembled.

System hole pattern 50 : 50 mm steps.

Solid floor plates safely transfer the loads to the floor.

► **Longitudinal beams**

with welded 5-hook rear lips. These guarantee an interlocking connection with the rack supports.

Adjustable using the system hole pattern 50:50 mm.

2 retaining pins (included in the scope of delivery) per section are required to prevent unintentional removal.

The load specifications apply for uniformly distributed loads.

The order numbers apply for one beam.

► **Longitudinal beam rack system dimensions**

Storage in depth direction

Pallet dimensions	Insertion depth	Rack depth
800 x 1,200 mm	1,200 mm	1,050 mm
1,000 x 1,200 mm	1,200 mm	1,050 mm
1,200 x 1,200 mm	1,200 mm	1,050 mm

Storage in transverse direction

Pallet dimensions	Insertion depth	Rack depth
800 x 1,200 mm	800 mm	850 mm
1,000 x 1,200 mm	1,000 mm	1,050 mm

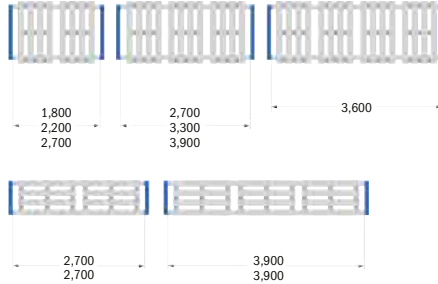

Longitudinal beams

Compatible with WR 600 longspan racking systems

Chapter C, from page C1

Longitudinal beams with INP profile

Item	Load/ pair (kg)	Profile type	Order no.	Item	Load/ pair (kg)	Profile type	Order no.	Item	Load/ pair (kg)	Profile type	Order no.
Length 1,800 mm				Length 2,200 mm				Length 2,700 mm			
TRV1-180-08-I	3,000	INP 80	321500	TRV1-220-08-I	2,500	INP 80	321540	TRV1-270-08-I	2,100	INP 80	321590
TRV1-180-10-I	4,500	INP 100	321660	TRV1-220-10-I	4,200	INP 100	321700	TRV1-270-10-I	3,500	INP 100	321750
Length 2,900 mm				Length 3,300 mm				Length 3,600 mm			
TRV1-290-08-I	1,900	INP 80	321610	TRV1-330-08-I	1,400	INP 80	321650	TRV1-360-10-I	2,300	INP 100	321840
TRV1-290-10-I	3,300	INP 100	321770	TRV1-330-10-I	2,700	INP 100	321810	TRV1-360-12-I	3,900	INP 120	322060
TRV1-290-12-I	4,500	INP 120	321990	TRV1-330-12-I	4,400	INP 120	322030	TRV1-390-10-I	2,000	INP 100	321870
Length 3,900 mm											
TRV1-390-12-I	3,400	INP 120	322090								

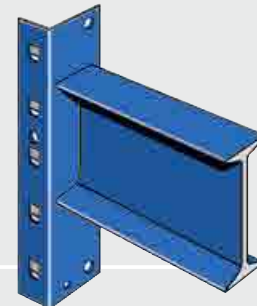

Longitudinal beams with CE profile

Item	Load/ pair (kg)	Profile type	Order no.	Item	Load/ pair (kg)	Profile type	Order no.	Item	Load/ pair (kg)	Profile type	Order no.
Length 1,800 mm				Length 2,200 mm				Length 2,700 mm			
TRV1-180-085-30 CE	3,200	CE 80	322160	TRV1-220-085-30 CE	2,500	CE 80	322200	TRV1-270-085-30 CE	1,700	CE 80	322250
TRV1-180-105-30 CE	4,200	CE 100	on req.*	TRV1-220-105-30 CE	3,500	CE 100	on req.*	TRV1-270-105-30 CE	2,600	CE 100	on req.*
TRV1-180-115-30 CE	4,500	CE 110	322720	TRV1-220-115-30 CE	3,900	CE 110	322760	TRV1-270-115-30 CE	3,000	CE 110	322810
Length 2,900 mm				Length 3,300 mm				Length 3,600 mm			
TRV1-290-085-30 CE	1,500	CE 80	on req.*	TRV1-330-115-30 CE	2,200	CE 110	322870	TRV1-360-115-30 CE	1,900	CE 110	322900
TRV1-290-105-30 CE	2,300	CE 100	on req.*	TRV1-330-125-30 CE	2,600	CE 120	on req.*	TRV1-360-125-30 CE	2,300	CE 120	on req.*
TRV1-290-115-30 CE	2,700	CE 110	322830	TRV1-330-145-30 CE	3,100	CE 140	323430	TRV1-360-145-30 CE	2,700	CE 140	323460
TRV1-290-125-30 CE	3,200	CE 120	on req.*								
TRV1-290-145-30 CE	3,800	CE 140	323390								
Length 3,900 mm											
TRV1-390-145-30 CE	2,300	CE 140	323490								

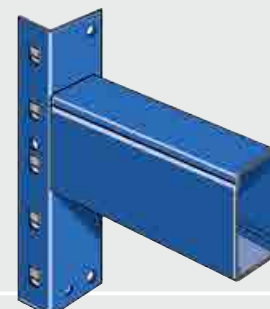

* Minimum order quantity on request.



PR 600 accessories

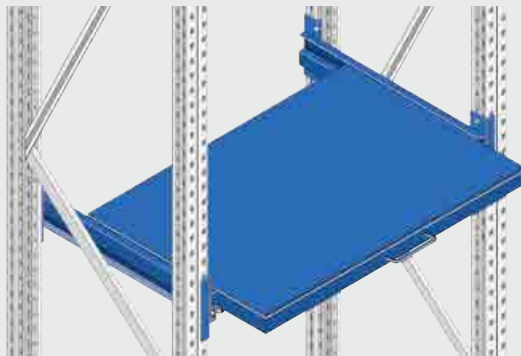

Extendable shelf, sheet metal cladding, smooth

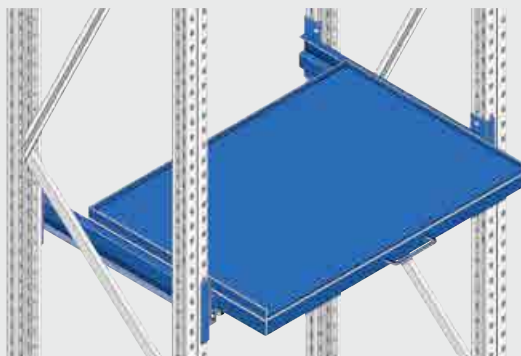

Extendable shelf, sheet metal cladding, 3-sided rolling edge

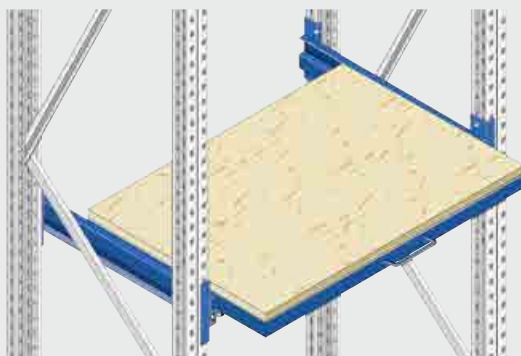

Extendable shelf, chipboard cladding

Heavy duty extendable shelves

Precision construction made of welded steel profile with precise steel ball bearings. The guide rails are bolted to the frame and can be adjusted using the system hole pattern of 50 : 50 mm. A double lock secures the extendable shelf when it is pulled out and pushed in. Load capacity of up to 1,000 kg with an evenly distributed load.

Heavy duty extendable shelves, 67% extendable

Item	Frame depth (mm)	Usable depth (mm)	Extension length (mm)	Load capacity (kg)	Order no.
------	------------------	-------------------	-----------------------	--------------------	-----------



Extendable shelf, sheet metal cladding, smooth

For racks with clear bay width 900 mm, usable width 800 mm.

AB 08.091	850	800	530	1,000	143230
AB 12.091	1,250	1,200	830	1,000	143260

For racks with clear bay width 1,300 mm, usable width 1,200 mm.

AB 08.131	850	800	530	1,000	143290
AB 12.131	1,250	1,200	830	1,000	143320

Extendable shelf, sheet metal cladding, 3-sided rolling edge

For racks with clear bay width 900 mm, usable width 800 mm.

AB 08.092	850	800	530	1,000	143240
AB 12.092	1,250	1,200	830	1,000	143270

For racks with clear bay width 1,300 mm, usable width 1,200 mm.

AB 08.132	850	800	530	1,000	143300
AB 12.132	1,250	1,200	830	1,000	143330

Extendable shelf, chipboard cladding

For racks with clear bay width 900 mm, usable width 800 mm.

AB 08.093	850	800	530	1,000	143250
AB 12.093	1,250	1,200	830	1,000	143280

For racks with clear bay width 1,300 mm, usable width 1,200 mm.

AB 08.133	850	800	530	1,000	143310
AB 12.133	1,250	1,200	830	1,000	143340

Heavy duty extendable shelves, 100% extendable

Item	Frame depth (mm)	Usable depth (mm)	Extension length (mm)	Load capacity (kg)	Order no.
------	------------------	-------------------	-----------------------	--------------------	-----------



Extendable shelf, sheet metal cladding, smooth

For racks with clear bay width 900 mm, usable width 800 mm.

AB 08.091 V	850	800	800	1,000	143800
AB 12.091 V	1,250	1,200	1,200	1,000	143860

For racks with clear bay width 1,300 mm, usable width 1,200 mm.

AB 08.131 V	850	800	800	1,000	143830
AB 12.131 V	1,250	1,200	1,200	1,000	143890

Extendable shelf, sheet metal cladding, 3-sided rolling edge

For racks with clear bay width 900 mm, usable width 800 mm.

AB 08.092 V	850	800	800	1,000	143810
AB 12.092 V	1,250	1,200	1,200	1,000	143870

For racks with clear bay width 1,300 mm, usable width 1,200 mm.

AB 08.132 V	850	800	800	1,000	143840
AB 12.132 V	1,250	1,200	1,200	1,000	143900

Extendable shelf, chipboard cladding

For racks with clear bay width 900 mm, usable width 800 mm.

AB 08.093 V	850	800	800	1,000	143820
AB 12.093 V	1,250	1,200	1,200	1,000	143880

For racks with clear bay width 1,300 mm, usable width 1,200 mm.

AB 08.133 V	850	800	800	1,000	143850
AB 12.133 V	1,250	1,200	1,200	1,000	143910

Order no. = on stock

Accessories

Cable drum sizes as per DIN 46 391

Nominal size	External Ø (mm)	Internal Ø (mm)	Width (mm)	Clear bay width (mm)	Max. load-bearing capacity (kg)
N 5	470	56	470	900	100
N 6	630	56	470	900	100
N 7	710	80	550	900	250
N 8	800	80	550	900	650
N 9	900	80	710	1,100	800
N 10	1,050	80	710	1,100	1,000
N 12	1,250	80	930	1,300	1,500

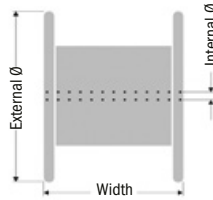

Cable drum axles

Cable drum axles made of hollow profile for fitting the cable drum.

Item	Clear bay width (mm)	Design for	Cone type	for cable drums	Order no.
TRA KM 0905	900	Type KM	AK 33	N 5 - N 6	143410
TRA KM 0910		Type KM	AK 48	N 7 - N 8	143920
TRA KM 1105	1,100	Type KM	AK 33	N 5 - N 6	143930
TRA KM 1110		Type KM	AK 48	N 7 - N 8	143420
TRA KM 1115		Type KM	AK 60	N 9 - N 10	143430
TRA KM 1315	1,300	Type KM	AK 60	N 9 - N 12	143440

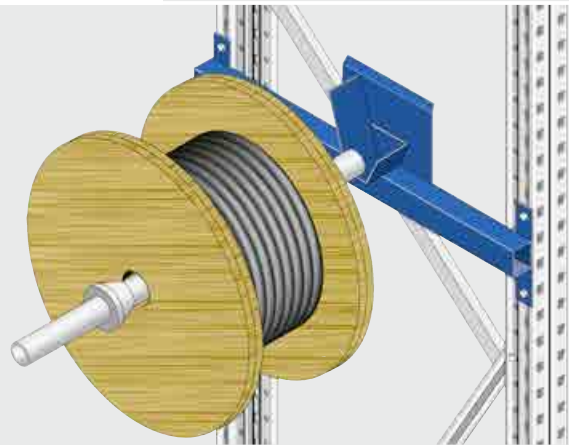

QT KM cable drum beam

Cable drum beams

Cable drum beams made of square hollow profile are bolted onto the rack supports. Adjustment 50 : 50 mm, shaft fitting with tray as a load-dependent brake and for low-noise unwinding.

Item	Frame depth (mm)	Type	for cable drums	Order no.
QT KM 6208	850	with tray	N 5 - N 12	143370
QT KM 6210	1,050	with tray	N 5 - N 12	143390

Cones

With the adjusting screw for centering the cable drum on the shaft.

Item	for cable drums	Material	Order no.
AK 33	N 5 - N 6	Polyamide	143940
AK 48	N 7 - N 8	Polyamide	143350
AK 60	N 9 - N 12	Polyamide	143360

U 100 horizontal braces

With welded 5-hook rear lips guarantee an interlocking connection with the rack supports. Adjustment 50 : 50 mm steps.

4 retaining pins (included) per pair are required to prevent unintentional removal.

With holes for mounting the front-to-back supports.

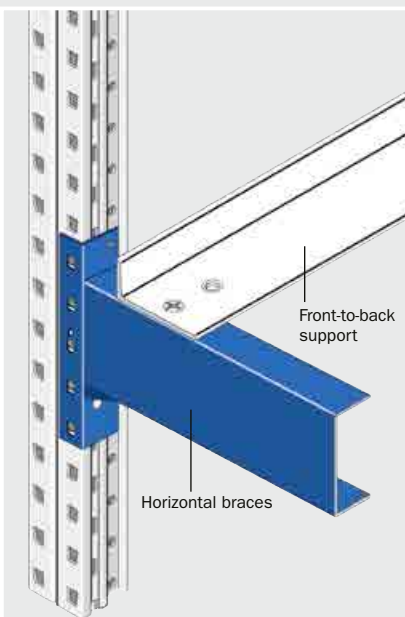

Item	Length (mm)	Pallet/container depth (mm)	Order no.
LVU 090	900	800	116930
LVU 110	1,100	1,000	116940
LVU 130	1,300	1,200	116950

Floor anchor

The frame needs to be anchored to ensure the stability of the pallet racking systems. M10 expansion anchors are used for a normal C20/25 concrete floor; M10 adhesive anchors are used for floors containing magnesium.

Item		Order no.
BA 10 SL	M 10 expansion anchor	67030
BA 10 VA	M 10 adhesive anchor	67390

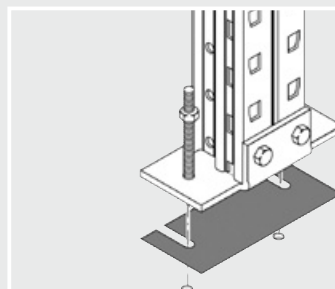
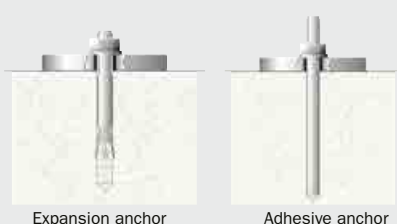

Base shims

To compensate for uneven ground, galvanized.

Item	Thickness (mm)	Support profile	Order no.
for PR 350 pallet racking systems			
AP 35.81	1	U 70	151000
AP 35.81	1	U 80	151000
AP 35.11	1	U 100	151020
for PR 600 pallet racking systems			
AP 60.91	1	all	143150
AP 60.92	2	all	155010

Insulation plates

Insulation plates made of plastic are needed for each rack support in order to prevent corrosion on floors containing magnesium.

Item	Thickness (mm)	Support profile	Order no.
for PR 350 pallet rackings			
IP 35.81	1	U 70	151040
IP 35.81	1	U 80	151040
IP 35.11	1	U 100	151050
for PR 600 pallet rackings			
IP 60.91	1	all	155020



Accessories for PR 350 and PR 600

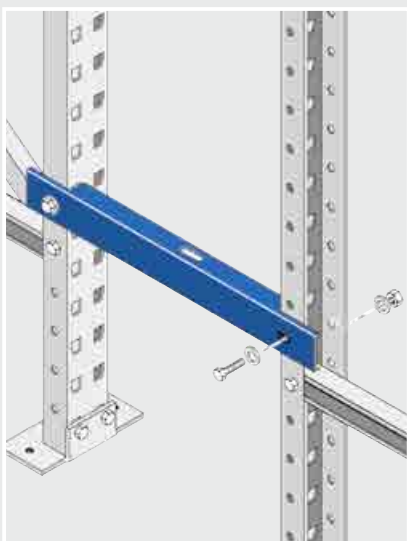

Spacers

Two single-row racks can be positioned one behind the other and then connected with spacers to form double-row racks. The length of the spacers is calculated from the difference between the rack depth and loading aids/loading unit plus 100 mm.

Item	Distance (mm)	Order no.
D 50 L	50	151060
D 100 L	100	151070
D 150 L	150	151080
D 200 L	200	151090
D 250 L	250	151100
D 300 L	300	151110
D 350 L	350	151120
D 400 L	400	151130
D 450 L	450	151140
D 500 L	500	151150

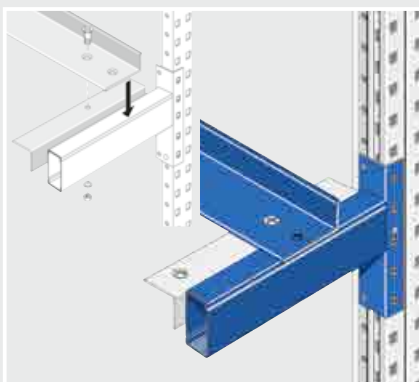

Fixing angle for front-to-back supports

Fitting options for front-to-back supports, either designed for euro pallets, industrial pallets or DIN-box mesh box pallets.

Item	Clear bay width (mm)	Order no.
AW 18	1,800	155030
AW 22	2,200	155040
AW 27	2,700	155050
AW 29	2,900	155060
AW 33	3,300	155070
AW 36	3,600	155080
AW 39	3,900	155090

Front-to-back support made of angled profile for pallet and container storage

For the fitting loading aids in pallet racking systems. Loading aids for each pair of front-to-back supports are required for containers without a stable support surface on longitudinal beams. In the case of transverse storage of pallets and containers, one pair of front-to-back supports are required for each loading aid. Locking brackets are required for fastening and securing against sliding on the longitudinal beams (as fig. above).

Cross section L 80/40/6

Load capacity up to 1,000 kg

Without backstop

Item	Frame depth (mm)	Pallet/ container depth (mm)	Order no.
QA85	850	800	155100
QA105	1,050	1,000	155120
QA125-10	1,050	1,200	155260
QA125	1,250	1,200	155140

With 30 mm backstop

Item	Frame depth (mm)	Pallet/ container depth (mm)	Order no.
QA85A	850	800	155110
QA105A	1,050	1,000	155130
QA125-10A	1,050	1,200	155280
QA125A	1,250	1,200	155150

Cross section L 100/50/6

Load capacity up to 1,500 kg

Without backstop

Item	Frame depth (mm)	Pallet/ container depth (mm)	Order no.
QA855	850	800	155160
QA1055	1,050	1,000	155180
QA1255-10	1,050	1,200	155270
QA1255	1,250	1,200	155200

With 40 mm backstop

Item	Frame depth (mm)	Pallet/ container depth (mm)	Order no.
QA855A	850	800	155170
QA1055A	1,050	1,000	155190
QA1255-10A	1,050	1,200	155290
QA1255A	1,250	1,200	155210



Front-to-back supports

The front-to-back supports are placed between the beams. The load specifications apply for uniformly distributed loads. For point loads they are not suitable.

Item	Frame depth (mm)	Max. pallet weight with 2 front-to-back supports (kg)	Order no.
TA-C-085-10	850	1,000	6700196
TA-C-105-10	1,050	1,000	6700197



Fork spacers

For storing wooden pallets, sheet metal packages, boxes, containers or other large storage objects. Ground clearance for forklifts 100 mm, max. load per piece 2,000 kg for evenly distributed loads.

Item	for frame depth (mm)	Order no.
QU 851	850	155220
QU 1051	1,050	155230
QU 1251	1,250	155240

Order no. = on stock



Accessories for PR 350 and PR 600

Mesh panels

Placed on longitudinal beams and locked in place. Mesh size 33 x 33 mm. Two-piece for clear bay width 2,200 mm. The load specifications apply for evenly distributed loads. The variants listed are not suitable for point loads. Other versions available on request.

Supported mesh panels for INP and CE beam profiles

Item	Frame depth (mm)	Clear bay width (mm)	Support member height (mm)	Compartment load (kg)	Order no.
FGA18-085-30-134X	850	1,800	30	1,600	156090
FGA18-105-30-134X	1,050	1,800	30	1,400	156160
FGA18-125-35-140X	1,250	1,800	35	1,500	156230
FGA22-085-30-134X	850	2,200	30	2,000	156100
FGA22-105-30-134X	1,050	2,200	30	1,700	156170
FGA22-125-35-140X	1,250	2,200	35	1,900	156240
FGA27-085-30-134X	850	2,700	30	2,500	156110
FGA27-105-30-134X	1,050	2,700	30	2,100	156180
FGA27-125-35-140X	1,250	2,700	35	2,300	156250
FGA29-085-30-134X	850	2,900	30	2,700	156120
FGA29-105-30-134X	1,050	2,900	30	2,300	156190
FGA29-125-35-140X	1,250	2,900	35	2,500	156260
FGA33-085-30-134X	850	3,300	30	3,000	156130
FGA33-105-30-134X	1,050	3,300	30	2,600	156200
FGA33-125-35-140X	1,250	3,300	35	2,900	156270
FGA36-085-30-134X	850	3,600	30	3,300	156140
FGA36-105-30-134X	1,050	3,600	30	2,800	156210
FGA36-125-35-140X	1,250	3,600	35	3,100	156280
FGA39-085-30-134X	850	3,900	30	3,500	156150
FGA39-105-30-134X	1,050	3,900	30	3,100	156220
FGA39-125-35-140X	1,250	3,900	35	3,400	156290

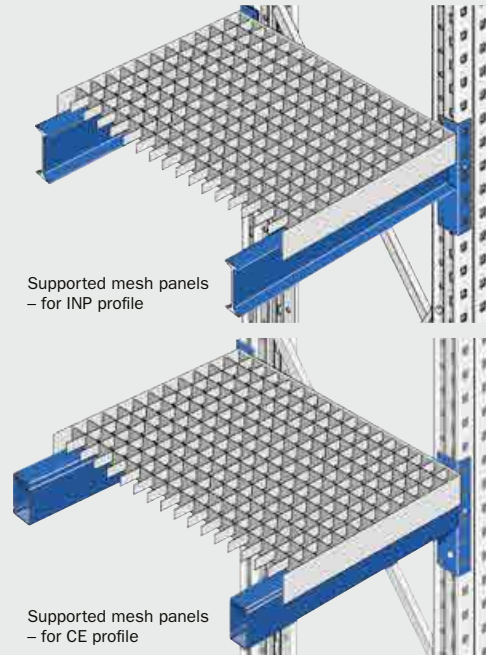

Sheet steel panels

C-shaped bevel. Locking in depth direction through short-side overlap of the beams. Individual or multiple covers can be used. The load specifications apply for evenly distributed loads.

Clear bay width (mm)	Panel width (mm)	Number of panels
1,800	300	6
2,200	300	6
	200	2
2,700	300	9
2,900	300	9
	200	1

Clear bay width (mm)	Panel width (mm)	Number of panels
3,300	300	11
3,600	300	12
3,900	300	13

Panel width 200 mm

Item	for frame depth (mm)	Load (kg)	Order no.
FPA 20-070-40-40X	700	740	193140
FPA 20-085-40-40X	850	680	193150
FPA 20-105-40-40X	1,050	550	193160
FPA 20-125-40-40X	1,250	460	193170

Panel width 300 mm

Item	for frame depth (mm)	Load (kg)	Order no.
FPA 30-070-40-30X	700	270	193100
FPA 30-070-40-50X		730	193180
FPA 30-085-40-30X	850	340	193110
FPA 30-085-40-50X		700	193190
FPA 30-105-40-30X	1,050	200	193120
FPA 30-105-40-50X		630	193200
FPA 30-125-40-30X	1,250	190	193130
FPA 30-125-40-50X		500	193210

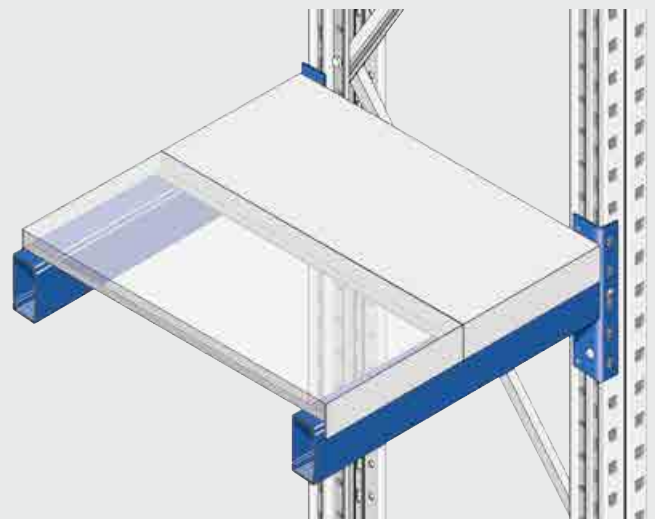

Accessories for PR 350 and PR 600, safety accessories for pallet racking systems

Chipboard

Placed on the profile of the INP or CE longitudinal beams. Secured against moving with fixing brackets. Two-piece for clear bay widths exceeding 3,300 mm. The load specifications apply for evenly distributed loads. The variants listed are not suitable for point loads. Other versions available on request. Surface: untreated.

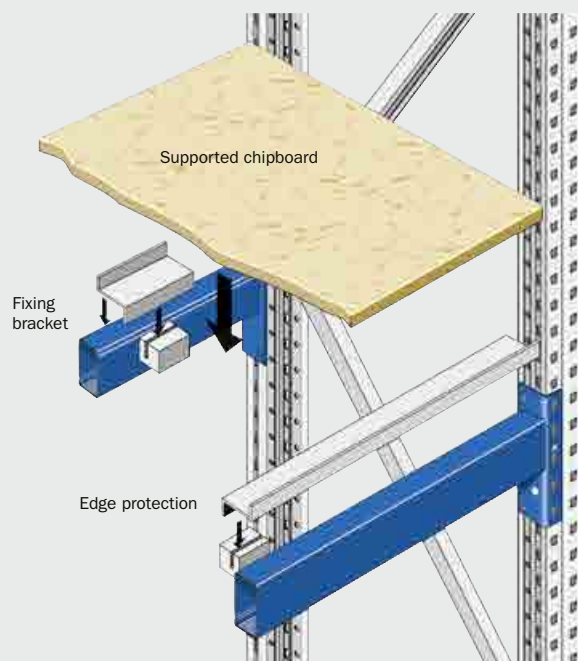

Edge protection

For 38 mm chipboard and INP/CE longitudinal beams, incl. spacers.

Item	Clear bay width (mm)	Order no.
KN 1824	1,800	157140
KN 2224	2,200	157150
KN 2724	2,700	157160
KN 2924	2,900	157170
KN 3324	3,300	157180
KN 3624	3,600	157190
KN 3924	3,900	157200

Fixing bracket

For 38 mm chipboard and INP/CE longitudinal beams. 4 fixing brackets are required for the clear bay width 1,800 to 2,900 mm and 8 for the clear bay width 3,300 to 3,900 mm.

FSHB 24	Fixing bracket, incl. spacer block (plastic)	1 pc.	156910
---------	--	-------	--------

Corner protector

Sturdy, angle profile with strong floor plate, including an anchor for attachment to the hall floor.

ES 400 C corner protector



Item	Height (mm)	Order no.
ES 400 C	400	157390

38 mm thick, normal compression for INP and CE profiles

Item	Frame depth (mm)	Clear bay width (mm)	Comp. load (kg)	Order no.
FSA 18-085-38-NX	850	1,800	1,300	306840
FSA 18-105-38-NX	1,050	1,800	950	306980
FSA 18-125-38-NX	1,250	1,800	600	307120
FSA 22-085-38-NX	850	2,200	1,600	306850
FSA 22-105-38-NX	1,050	2,200	1,100	306990
FSA 22-125-38-NX	1,250	2,200	750	307130
FSA 27-085-38-NX	850	2,700	2,000	306860
FSA 27-105-38-NX	1,050	2,700	1,400	307000
FSA 27-125-38-NX	1,250	2,700	900	307140
FSA 29-085-38-NX	850	2,900	2,200	306870
FSA 29-105-38-NX	1,050	2,900	1,500	307010
FSA 29-125-38-NX	1,250	2,900	1,000	307150
FSA 33-085-38-NX	850	3,300	2,500	306880
FSA 33-105-38-NX	1,050	3,300	1,700	307020
FSA 33-125-38-NX	1,250	3,300	1,100	307160
FSA 36-085-38-NX	850	3,600	2,700	306890
FSA 36-105-38-NX	1,050	3,600	1,900	307030
FSA 36-125-38-NX	1,250	3,600	1,200	307170
FSA 39-085-38-NX	850	3,900	2,900	306900
FSA 39-105-38-NX	1,050	3,900	2,000	307040
FSA 39-125-38-NX	1,250	3,900	1,300	307180

38 mm thick, highly compressed for INP and CE profiles

Item	Frame depth (mm)	Clear bay width (mm)	Comp. load (kg)	Order no.
FSA 18-085-38-HX	850	1,800	2,100	306910
FSA 18-105-38-HX	1,050	1,800	1,500	307050
FSA 18-125-38-HX	1,250	1,800	1,000	307190
FSA 22-085-38-HX	850	2,200	2,600	306920
FSA 22-105-38-HX	1,050	2,200	1,900	307060
FSA 22-125-38-HX	1,250	2,200	1,300	307200
FSA 27-085-38-HX	850	2,700	3,200	306930
FSA 27-105-38-HX	1,050	2,700	2,300	307070
FSA 27-125-38-HX	1,250	2,700	1,600	307210
FSA 29-085-38-HX	850	2,900	3,500	306940
FSA 29-105-38-HX	1,050	2,900	2,500	307080
FSA 29-125-38-HX	1,250	2,900	1,700	307220
FSA 33-085-38-HX	850	3,300	4,000	306950
FSA 33-105-38-HX	1,050	3,300	2,800	307090
FSA 33-125-38-HX	1,250	3,300	1,900	307230
FSA 36-085-38-HX	850	3,600	4,000	306960
FSA 36-105-38-HX	1,050	3,600	3,100	307100
FSA 36-125-38-HX	1,250	3,600	2,100	307240
FSA 39-085-38-HX	850	3,900	4,000	306970
FSA 39-105-38-HX	1,050	3,900	3,300	307110
FSA 39-125-38-HX	1,250	3,900	2,300	307250

Guard

To protect the rack supports against being damaged by ground conveyors, 140 mm wide, U-shaped, including 3 floor anchors.

Guard



Item	Height (mm)	Order no.
AS 400	400	157420

Order no. = on stock



Security regulations
 Fixed racks that are served by non-track-bound ground conveyors require adequate protection against damage to the rack frame on the corners and gangways

Safety accessories for pallet racking systems

Upright protector with rubber buffer

U-profile, 750 mm high, including 4 rubber-metal buffers.

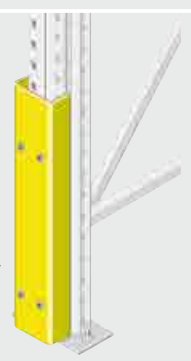

Upright protector with rubber buffer

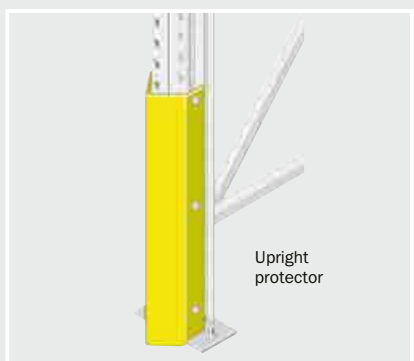

Upright protector

Item	from profile	for support profile	Order no.
STS 100G-750	U 100	P 75, U 70, U 80	158501
STS 110G-750	U 110	P 90	158502
STS 120G-750	U 120	P 100, U 100	158503

Upright protector

For reinforcing the front rack supports and as a protection against damage, 750 mm high, including fixing kit.

for PR 350 system:

Item	for support width (mm)	Height (mm)	for support profile	Order no.
STS 70-3-400	70	400	U 70	158500
STS 70-3-750		750	U 70	158570
STS 80-3-400	80	400	U 80	158510
STS 80-3-750		750	U 80	158580
STS 100-3-400	100	400	U 100	158520
STS 100-3-750		750	U 100	158590

for PR 600 system:

Item	for support width (mm)	Height (mm)	for support profile	Order no.
STS 75-6-400	75	400	P 75	158530
STS 75-6-750		750	P 75	158600
STS 90-6-400	90	400	P 90	158540
STS 90-6-750		750	P 90	158610
STS 100-6-400	100	400	P 100	158550
STS 100-6-750		750	P 100	158620
STS 120-6-400	120	400	P 120	158560
STS 120-6-750		750	P 120	158630

Buffer

Particularly vulnerable areas of pallet racking systems, such as gangways or heavily frequented passages, require sturdy buffers.

Form B

400 mm high, 245 mm wide, including floor anchors. For support profiles Type P 75 and P 90.

Item	for frame depth (mm)	Order no.
RS24 0854 B	850	151510
RS24 1054 B	1,050	151520
RS24 1254 B	1,250	151530
RS24 1804 B	1,800	151540
RS24 2204 B	2,200	151550
RS24 2354 B	2,350	151560
RS24 2604 B	2,600	151610

Form B

400 mm high, 265 mm wide, including floor anchors. For support profiles Type P 100 and P 120.

Item	for frame depth (mm)	Order no.
RS26 0854 B	850	151400
RS26 1054 B	1,050	151410
RS26 1254 B	1,250	151420
RS26 1804 B	1,800	151430
RS26 2204 B	2,200	151440
RS26 2354 B	2,350	151450
RS26 2604 B	2,600	151500

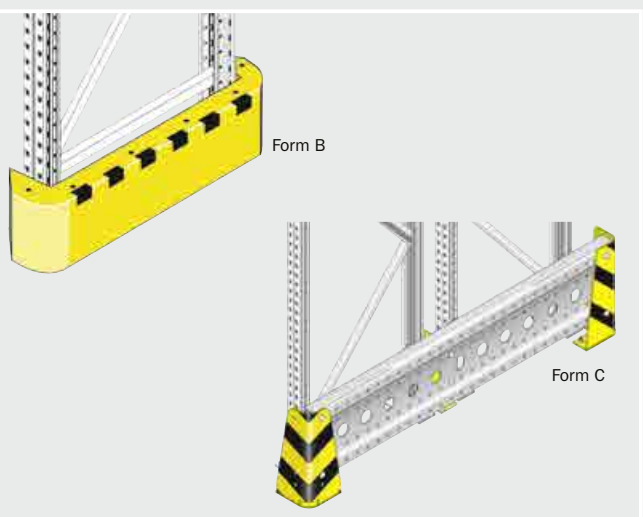

Form C

With a sturdy C-Sigma profile, 400 mm high, 75 mm wide, including floor anchor, with additional support above 1,800 mm long.

Item	for frame depth (mm)	Order no.
RS 854 C	850	157430
RS 1054 C	1,050	157440
RS 1254 C	1,250	157450
RS 1804 CZ	1,800	157690
RS 2204 CZ	2,200	157700
RS 2354 CZ	2,350	157710
RS 2604 CZ	2,600	157720

Boxes / containers
 Modular shelving
 Longspan racking
 Pallet racking
 Cantilever racking
 Mezzanines / platforms
 On-line shelving / KDR shelving
 Semi-automated solutions
 Logistics systems
 Appendix



Safety accessories for pallet racking systems

Mesh back panel cladding

The rear sides of free-standing racks must be secured to prevent the loading units from falling out. Observe the applicable safety regulations or ask our technical consultants.

The mesh back panels are made of mesh mats with defined lengths and heights. They are combined depending on the rack height and clear bay widths. The mesh spacing is 100 x 50 mm. A GRM mesh segment consists of 2 C-profiles and the necessary mesh mats. Depending on the number of mesh mats, mesh connectors and compensating rods are required to secure the bracket sets (including fixing kit) – please order separately.

Spacing: 180 mm outer edge of the rack supports – GRM inner edge;
220 mm outer edge of the rack supports – inner edge GRM.

Ordering example

For 3,600 mm high rack you require:

1 723 mm high mesh segment height 723 mm and
2 1,273 mm high mesh segments.

For a 3,600 mm high pallet racking and the bay width 3,900 mm order:

1x GRM-3907, 2x GRM-3912, 4x bracket set,
4x compensating rods, 4x mesh connectors



Rack height in mm	2,500	3,000	3,600	4,100	4,700	5,200	5,800	6,300	6,900	7,400
Lower dimension in mm	345	45	45	45	45	45	45	45	45	45
The number of required mesh segments										
H 773 mm	1	2	1	2	1	–	1	–	2	–
H 1,173 mm	–	–	–	2	2	1	4	3	1	5
H 1,273 mm	1	1	2	–	1	3	–	2	3	1
No. of console sets	3	4	4	5	5	5	6	6	7	7
No. of compensating rods	2	2	4	4	4	4	6	6	6	6

Mesh segment height 773 mm

Item	Clear bay width (mm)	Order no.
GRM-0907	900	6686319
GRM-1107	1,100	6686320
GRM-1307	1,300	6686321
GRM-1807	1,800	6686328
GRM-2207	2,200	6686329
GRM-2707	2,700	6686330
GRM-2907	2,900	6686331
GRM-3307	3,300	6686332
GRM-3607	3,600	6686333
GRM-3907	3,900	6686334

Mesh segment height 1,173 mm

Item	Clear bay width (mm)	Order no.
GRM-0911	900	6686322
GRM-1111	1,100	6686323
GRM-1311	1,300	6686324
GRM-1811	1,800	6686336
GRM-2211	2,200	6686337
GRM-2711	2,700	6686338
GRM-2911	2,900	6686339
GRM-3311	3,300	6686340
GRM-3611	3,600	6686341
GRM-3911	3,900	6686342

Mesh segment height 1,273 mm

Item	Clear bay width (mm)	Order no.
GRM-0912	900	6686325
GRM-1112	1,100	6686326
GRM-1312	1,300	6686327
GRM-1812	1,800	6686344
GRM-2212	2,200	6686345
GRM-2712	2,700	6686346
GRM-2912	2,900	6686347
GRM-3312	3,300	6686348
GRM-3612	3,600	6686349
GRM-3912	3,900	6686350

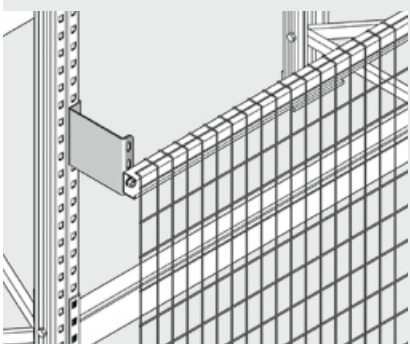

Console set (incl. fixing kit)

Item	Length (mm)	Frame depth (mm)	Order no.
without consideration of a end stop			
GRM-K2-060-S	60	850, 1,250	6690045
GRM-K2-130-S	130	1,050	6690046
with consideration of a end stop			
GRM-K2-180-S	180	850, 1,250	6690047
GRM-K2-340-S	340	1,050	6690050

An adapter plate is required to install brackets on U 70 profile. Further information is available on request.

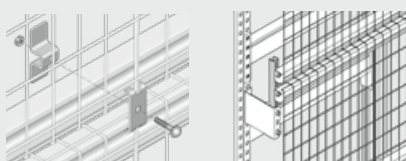

Item	Order no.
Mesh connector (see table above)	
GRM-GVS	6687406
Compensating rods (incl. fixing kit)	
GRM-ASS	6686298

Order no. = on stock

Mandatory labeling

The regulations of the trade associations demand labeling of rack facilities with all the necessary load specifications

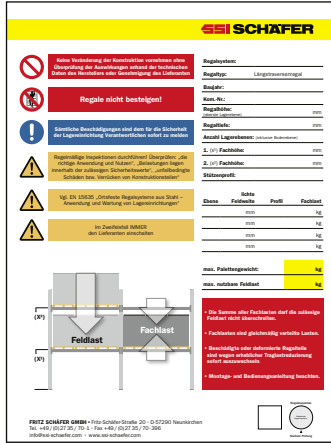
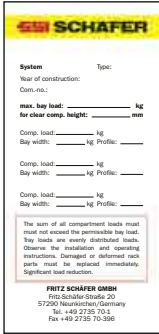

Safety accessories for pallet racking systems

Load signs

Item	W x H (mm)	Material	Order no.
PRTS 7050 LTR	450 x 600	Aluminum, incl. fixing kit	on req.*
PRTS 7050 QTR	450 x 600	Aluminum, incl. fixing kit	on req.*
TS 0615	60 x 150	PVC adhesive film	on req.*

* The technical data is defined via a time sheet. It is offered and invoiced as part of the price of the sign.

Frame extension at row end

Protects against lower units from falling out of the sides, 500 mm high including fixing kit.

Surface: Dust Gray, RAL 7037 or galvanized.

Note: Frame extensions at row end cannot be used in conjunction with mesh back panels.

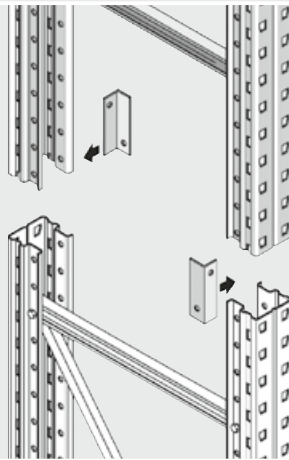

Item	System	Frame profile (mm)	Frame depth (mm)	Surface	Order no.
AN 78	PR 350	70	850	RAL 7037	33160
AN 68	PR 600	75	850	Galvanized	34870
AN 88	PR 350	80	850	RAL 7037	33170
AN 98	PR 600	90	850	Galvanized	34860
AN 18	PR 350	100	850	RAL 7037	33180
AN 71	PR 350	70	1,050	RAL 7037	33190
AN 61	PR 600	75	1,050	Galvanized	34880
AN 81	PR 350	80	1,050	RAL 7037	33200
AN 91	PR 600	90	1,050	Galvanized	34840
AN 11	PR 350	100	1,050	RAL 7037	33210
AN 72	PR 350	70	1,250	RAL 7037	33220
AN 62	PR 600	75	1,250	Galvanized	34890
AN 82	PR 350	80	1,250	RAL 7037	33230
AN 92	PR 600	90	1,250	Galvanized	34850
AN 12	PR 350	100	1,250	RAL 7037	33240

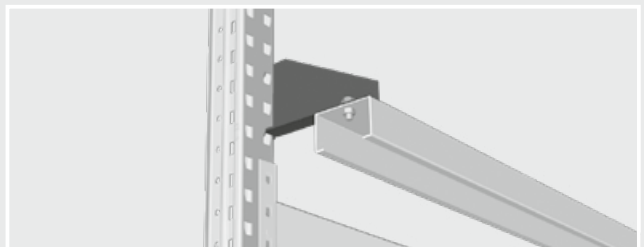
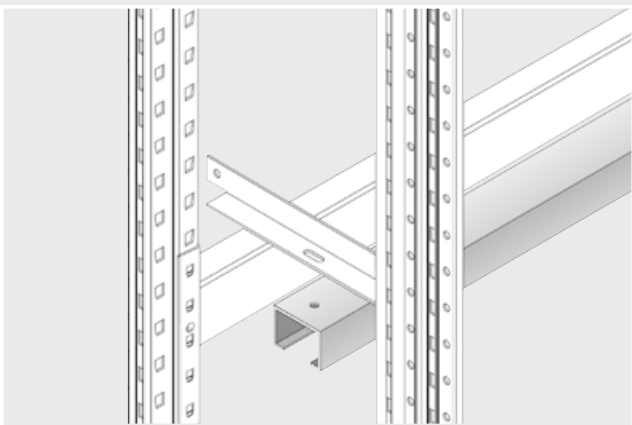

Accessories for end stops for single-row racks

Single-row racks require 2 brackets with 126 mm spacing for each end stop.

Item	for frame depth (mm)	Order no.
DSC-K105	1,050	6689690

End stops

Double-row racks require end stops if the distance between the loading aids or the load unit is less than 100 mm. On single-row racks, end stops prevent the load units from unintentionally falling out. Depending on the requirements, a 60 or 100 mm wide profile can be used.

Item	Clear bay width (mm)	Profile	Order no.
DSC060FW1900	1,900	C 60/40	6689260
DSC060FW2300	2,300	C 60/40	6689264
DSC060FW2700	2,700	C 60/40	6689268
DSC100FW2900	2,900	C 100/60	6689270
DSC100FW3300	3,300	C 100/60	6689274
DSC100FW3600	3,600	C 100/60	6689277
DSC100FW3900	3,900	C 100/60	6689280

Accessories for end stops for double-row racks

For double-face rack rows require 2 spacers as brackets for each end stop.

Further information is available on **page D14**.

Boxes / containers

Modular shelving

Longspan racking

Pallet racking

Cantilever racking

Mezzanines / platforms

On-line shelving / KDR shelving

Semi-automated solutions

Logistics systems

Appendix

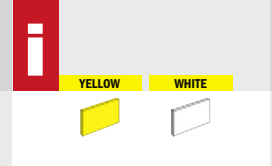

Storage and storage space marking

The potentials for accelerating logistics processes and, thus, permanently reducing costs are extremely high.

Both manual and computer-controlled warehouses can be optimized with visual warehouse organization procedures and systems.

Rapid and safe storage, retrieval and relocation significantly enhance the employees' productivity. Pickers and forklift drivers are guided to the right location in the shortest possible time.

The solution is a clearly understandable guidance system that can be implemented quickly and easily. At the same time, the investment to install the visual warehouse organization is particularly low.

Systematic numbering of all storage spaces and the number key form the basis and the prerequisite for efficient warehouse organization.

Each storage space is the signed a unique and unmistakable code, which consists of at least three coordinates: rack row, longitudinal position and height position.

Additional information can also be printed on the labels such as storage areas, check digits, barcodes and position arrows.

A diverse range of fonts, colors and sizes for signs, labels, label holders and ground markings are available.

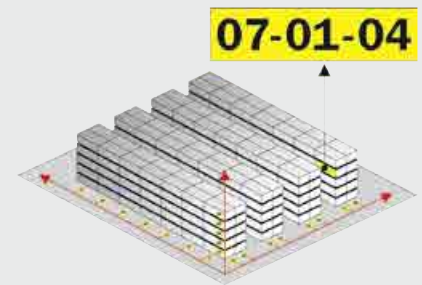

Please inquire if you would like a version that is not listed here.



Further versions

on request





from 2,000 units on request

Storage space labels

Self-adhesive polyethylene film,
Color: yellow, lettering: black,
up to 8 characters including separators.
Minimum order quantity: 100 pieces.

Quantity scale: 1 – 1,999 pieces

Item	W x H (mm)	Order no.
R SK 1230 SG	120 x 30	189900
R SK 1438 SG	140 x 38	189901
R SK 2265 SG	220 x 65	189902

from 2,000 units on request

Storage space labels

Self-adhesive polyethylene film,
Color: white, lettering: black,
up to 8 characters including separators.
Minimum order quantity: 100 pieces.

Quantity scale: 1 – 1,999 pieces

Item	W x H (mm)	Order no.
R SK 1230 SW	120 x 30	189903
R SK 1438 SW	140 x 38	189904
R SK 2265 SW	220 x 65	189905

Order no. = on stock

Storage and storage space marking

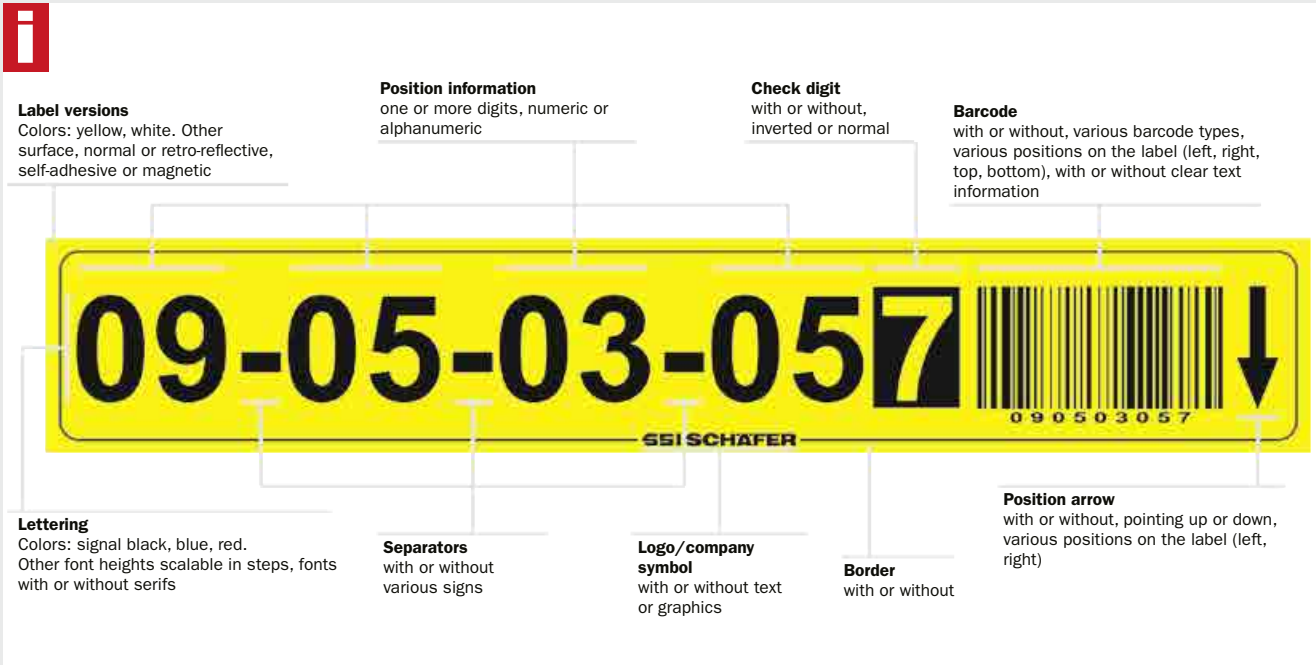

Storage space labels

Self-adhesive polyethylene film,
Color: yellow, lettering: black,
up to 8 characters including separators,
additionally with barcode.
Minimum order quantity: 100 pieces.

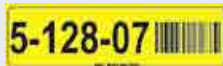

Quantity scale: 1 – 1,999 pieces

Item	W x H (mm)	Order no.
R SK 1230 SGB	192 x 38	189906
R SK 1438 SGB	224 x 38	189907
R SK 2265 SGB	380 x 65	189908

from 2,000 units on request



Storage space labels

Self-adhesive polyethylene film,
Color: white, lettering: black,
up to 8 characters including separators,
additionally with barcode.
Minimum order quantity: 100 pieces.



Quantity scale: 1 – 1,999 pieces

Item	W x H (mm)	Order no.
R SK 1230 SWB	192 x 38	189909
R SK 1438 SWB	224 x 38	189910
R SK 2265 SWB	380 x 65	189911

from 2,000 units on request



Boxes / containers

Modular shelving

Longspan racking

Pallet racking

Cantilever racking

Mezzanines / platforms

On-line shelving / KDR shelving

Semi-automated solutions

Logistics systems

Appendix

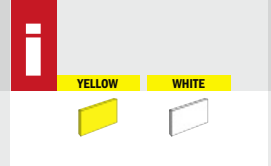

Storage and storage space marking



Floor markings

For the identification of pallet and (block) storage areas or driving and walking lanes, self-adhesive, thickness: 0.3 mm, color: yellow.

Item	Forms	PU	Order no.
R BM K	Circle	1	189917
R BM R	Circular blank	50	189918
R BM T	T-piece	10	189919
R BM KR	Cross	1	189920
R BM E	Corner piece with label	10	189921
			on req.



Rack row signs

Made of PVC, impact-resistant, color: yellow, Font: black, up to 2 characters, including fixing kit.

Item	W x H (mm)	Order no.
R RZ 2020	200 x 200	189912
R RZ 3030	300 x 300	189913
R RZ 5050	500 x 500	189914



Rack row angle sign

Made of PVC, impact-resistant, color: yellow, Font: black, up to 3 characters, including fixing kit.

Item	Length (mm)	Order no.
R RW 30300	300 x 300	189915



Label holder

Self-adhesive plastic label holders, total height 33 mm (for label height 30 mm). Without label inserts.

Item	Length (mm)	Order no.
K EH 0880	780	442518
K EH 1080	980	442538
K EH 1280	1,180	442558
K EH 1350	1,250	442565
K EH 1800	1,700	442610
K EH 2200	2,100	442650
K EH 2700	2,600	442700



Push-in label

Pre-perforated labels made of 120 g/m² paper, white, 20 labels on one DIN A4 sheet for self printing. Label format: 100 x 30 mm.

Item	Format (form)	Order no.
R EE 1030	DIN A4	189916

OPERATING NOTE

- Employees must be informed about and trained in the correct operation of the equipment.
- The permissible loads on the rack type plates must not be exceeded.
- Changes to the rack structure influence the load bearing capacity of the equipment. The effects must be examined and the supplier consulted.
- Damaged or deformed rack parts must be replaced immediately as their load bearing capacity is significantly reduced.
- Pallets, boxes or other loading equipment must be checked to ensure that it is in safe condition and replaced if damage is found.

FRITZ SCHÄFER GMBH
Fritz-Schäfer-Straße 20 · 57290 Neunkirchen/Germany
Tel. +49 2735 70-1 · Fax +49 2735 70-694

SAFETY NOTE

Please report all damage for safety purposes.

Responsible safety officer: _____

FRITZ SCHÄFER GMBH
Fritz-Schäfer-Straße 20 · 57290 Neunkirchen/Germany
Tel. +49 2735 70-1 · Fax +49 2735 70-694

Operating note / Safety note

FEM regulations for storage facilities.

Made of aluminum composite, W 420 x H 600 mm, multi-colored printing, incl. fixing kit.

Item	Order no.	Item	Order no.		
TS 7050 BH	Operating note	992305	TS 7050 SH	Safety note	992305

Order no. = on stock

Storage and storage space marking



Cleaning agents

For cleaning and preparing the adhesive surfaces for self-adhesive labels.

Item		Order no.
R RM	Cleaning agent 0.5 l	189922
R RA	Scraper	189923
R RT	Cleaning cloths 50 pcs.	189924



Chains

Red/white; chain stand with triangular, cement filled stand, including 2 hooks made of plastic – for fastening the chain barrier to the chain stand; chain barriers made of plastic, color change every 50 cm, colorfast and weather-resistant.

Item	Type	Order no.
R KS	Chain stand	189928
R KG	Chain barrier	189929



Warning marking tape made of PE film

66 meters long, 60 mm wide, yellow/black crosshatched.

Item	Type	Order no.
R WA LI	Pointing left	189927

SSI SCHÄFER

Numbering plan creation

The number plan is the basis for calculating the rack spaces.
For each column, please specify whether the lettering should be

- numeric or alphabetic
- and
- 1, 2 or 3 digits.

For alphabetic labels, please specify the corresponding number value.
A = 1, B = 2, C = 3 etc.

Here: all positions and 2 digit numeric

Warehouse Area	Rack row or aisle	Longitudinal position	Storage space or rack bay	Height position	Total
Example: 1 to 1 (1)	3 to 3 (1)	3 to 5 (3)	1 to 3 (3)	1 to 4 (4)	1 x 1 x 3 x 3 x 4 = 36
<input type="radio"/> numeric <input type="radio"/> 1 digit <input type="radio"/> alphabetic <input type="radio"/> 2 digits	<input type="radio"/> numeric <input type="radio"/> 1 digit <input type="radio"/> alphabetic <input type="radio"/> 2 digits <input type="radio"/> <input type="radio"/> 3 digits	<input type="radio"/> numeric <input type="radio"/> 1 digit <input type="radio"/> alphabetic <input type="radio"/> 2 digits <input type="radio"/> <input type="radio"/> 3 digits	<input type="radio"/> numeric <input type="radio"/> 1 digit <input type="radio"/> alphabetic <input type="radio"/> 2 digits <input type="radio"/> <input type="radio"/> 3 digits	<input type="radio"/> numeric <input type="radio"/> 1 digit <input type="radio"/> alphabetic <input type="radio"/> 2 digits <input type="radio"/> <input type="radio"/> 3 digits	<input type="radio"/> numeric <input type="radio"/> 1 digit <input type="radio"/> alphabetic <input type="radio"/> 2 digits
to	to	to	to	to	
to	to	to	to	to	
to	to	to	to	to	
to	to	to	to	to	
to	to	to	to	to	
to	to	to	to	to	
to	to	to	to	to	
to	to	to	to	to	
to	to	to	to	to	
to	to	to	to	to	
Total sum of the rack spaces					

SSI SCHÄFER • FRITZ SCHÄFER GMBH
 Fritz-Schäfer-Straße 20 · 57290 Neunkirchen/Germany
 Tel. +49 2735 70-1 · Fax +49 273570-396

i PDF template
on request



Internat. rescue sign EXIT

390 x 115 mm, made of aluminum.

Item	Type	Order no.
R IR LI	Pointing left	189932
R IR RE	Pointing right	189933
R IR AB	Down	189930
R IR AU	Up	189931



Prohibition signs made of aluminum

200 mm diameter, as per DIN 4844 -2.

Item	Type	Order no.
R VZ 20F12	"Pedestrians prohibited"	189925
R VZ 20U12	"Unauthorized access prohibited"	189926

PR 600 front-to-back beam racks

SSI SCHAEFER's front-to-back beam racks are outstanding for single-space storage. They are the ideal solution for this warehousing tasks. They make optimum use of the room height as almost none of the construction elements restrict the height of the goods being stored.

Front-to-back beam racks are especially suitable for order picking from laterally positioned containers and pallets. The

order picking height can be used optimally. The single-row design is also beneficial for high racks, especially when heavy goods are stored in high stacks.



Staging PR 600 front-to-back beams

Advantages of the front-to-back beam rack:

Virtually no restriction of storage height due to construction elements enables you to make optimum use of the room height. Front-to-back beam racks are especially suitable for order picking from laterally positioned containers and pallets. The crosspieces are self-locking and can be adjusted very easily without the use of tools.

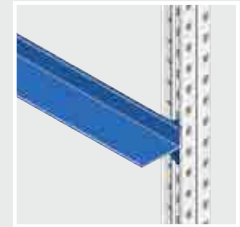
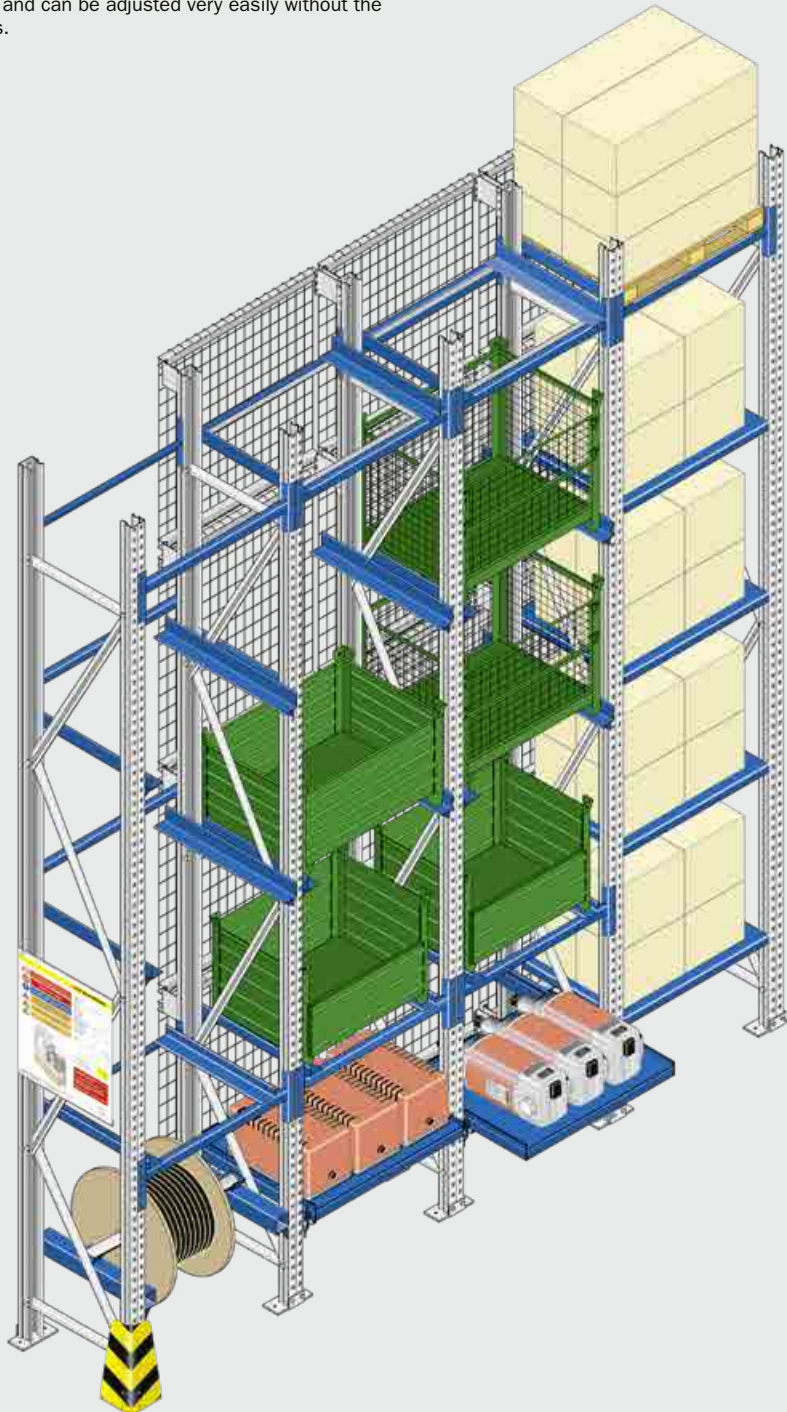

Front-to-back beam

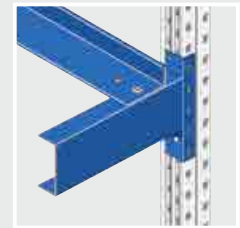

Front-to-back support with horizontal brace

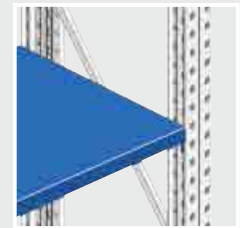

Shelf

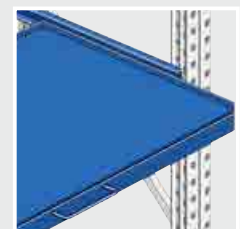

Extendable shelf

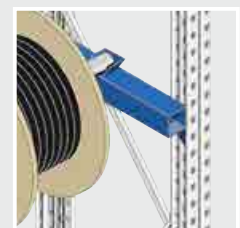

Cable drum beams



Corner protector



Load sign

Boxes /
containers

Modular
shelving

Longspan
racking

Pallet
racking

Cantilever
racking

Mezzanines /
platforms

On-line shelving /
KDR shelving

Semi-automated
solutions

Logistics
systems

Appendix

Drive-in and drive-through racking

SSI SCHÄFER's pallet racking systems are practically designed for use as drive-in and drive-through racking. This storage system proves its value especially when storing a small range of different articles in very large quantities. It provides maximum storage capacity in a minimum spatial volume.

The systems are loaded and unloaded using conventional forklifts that drive into the rack channels. Although direct access to all the stored pallets is only

possible to a limited extent, drive-in racking systems are an integral part of modern warehouse logistics, typically in transshipment warehouses.

Drive-in and drive-through pallet racking systems are accessed with front forklifts or reach trucks. The typical applications include the food and non-food industry, in particular a small range of articles stored in large quantities, such as fruit, fruit juices or care products. The design of the

front-to-back supports is an important aspect of the functionality of drive-in and drive-through racking. Preferably, drive-in and drive-through racking should be equipped with floor rails to protect the rack supports and provide forklift drivers with better guidance.

Consider the following system features if you are planning a new warehouse or intend to restructure an existing facility. We help you to plan and develop the most efficient logistics solution.



Further information

on request

Staging drive-in and drive-through racking

Advantages of the drive-in racking:

Maximum storage capacity with minimum spatial volume is the unique characteristic of drive-in racking systems. The racks are loaded and unloaded from one side. The channels can only be accessed in one direction.

Advantages of the drive-through racking:

Free-standing rack units can be accessed from both sides. A forklift can be driven through the racks. The advantage is that loading and unloading can be carried out separately.

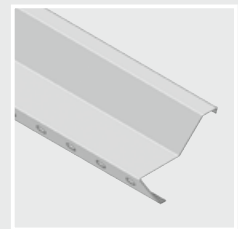
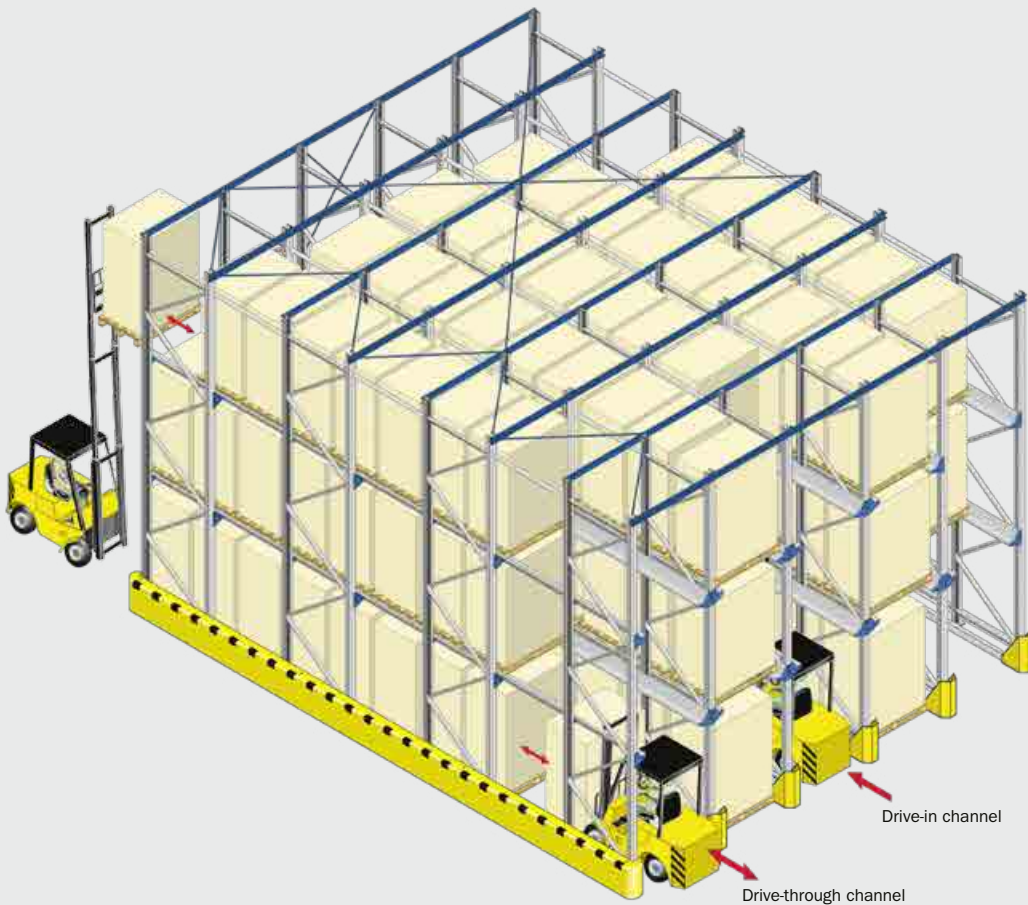

Front-to-back support

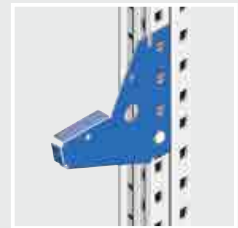

Attachment bracket

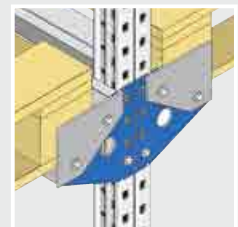

End stop

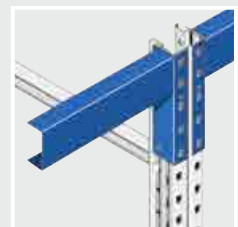

Horizontal brace

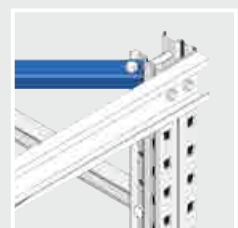

Horizontal cross brace

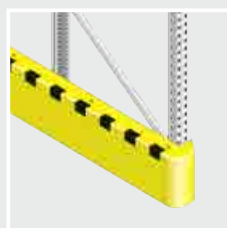
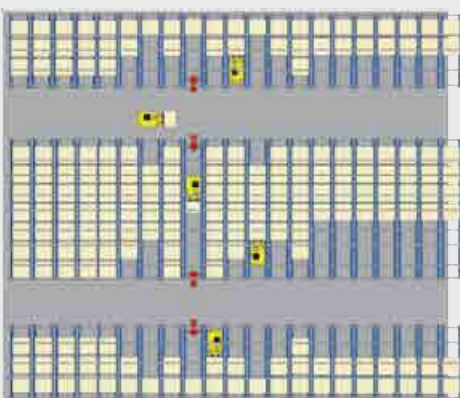

Buffer

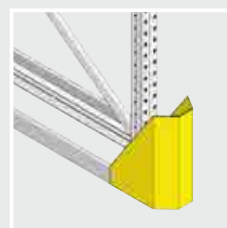

Guard and floor rails

Boxes / containers

Modular shelving

Longspan racking

Pallet racking

Cantilever racking

Mezzanines / platforms

On-line shelving / KDR shelving

Semi-automated solutions

Logistics systems

Appendix

Mobile racking for pallets and long goods

Available storage spaces cannot always be expanded to any desired extent. Space needs to be saved for new production areas. Mobile racking storage is worth considering wherever these requirements exist. Modern management concepts and sound planning enable previously unimagined options.

The mobile racking system is both simple and impressive. Any desired number of rack rows are mounted on traveling units and moved on rails using an electric motor. The access aisle is only opened where it is currently needed.

Consider these system advantages if you are planning a new warehouse or intend to restructure an existing facility.

- ▶ 85% increase in capacity with the same surface area.
- ▶ 60% less construction volume if you are planning a new construction.
- ▶ 40% space savings that you can use without having to construct a new building.

We help you to plan and develop the most efficient logistics solution.



i Further information

on request

Mobile rack staging

Mobile racking for pallet storage

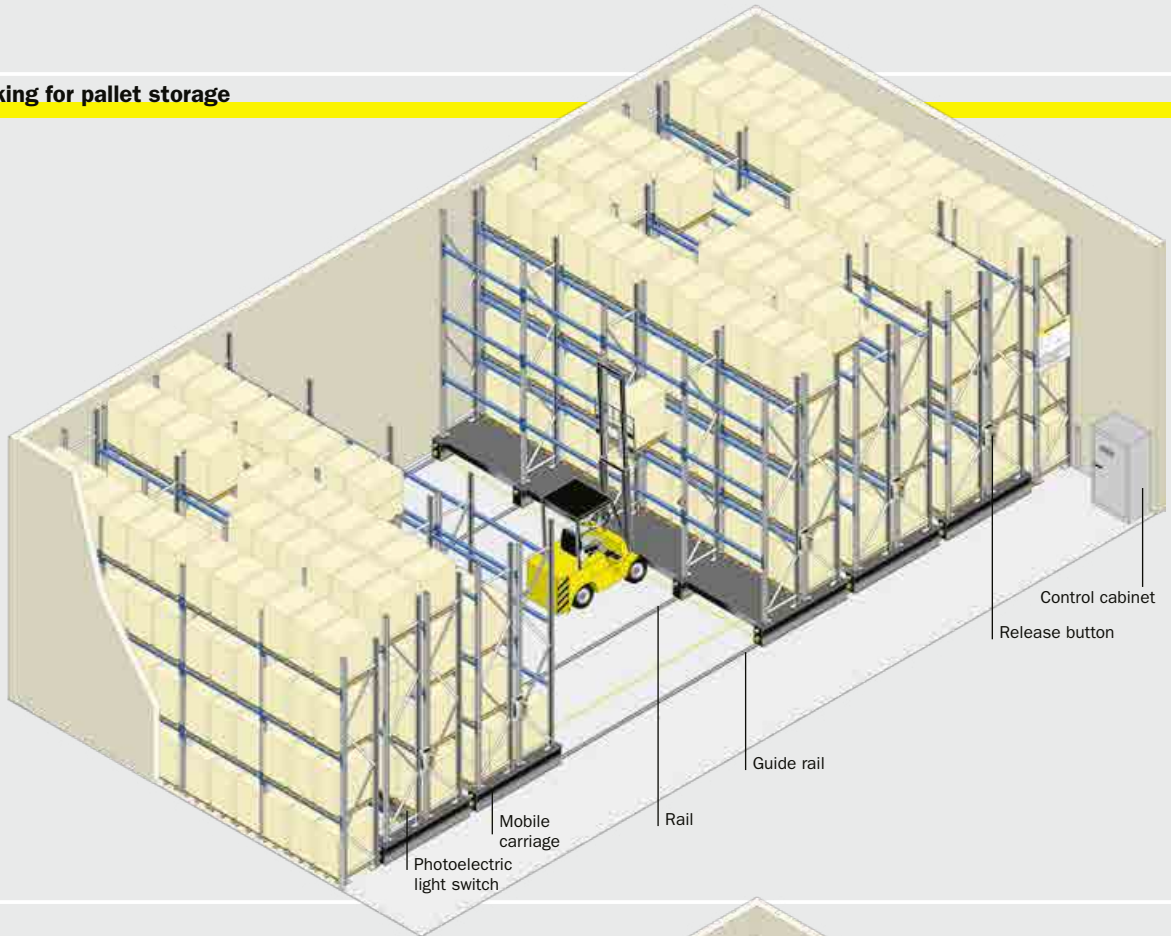

Mobile racking for long goods storage

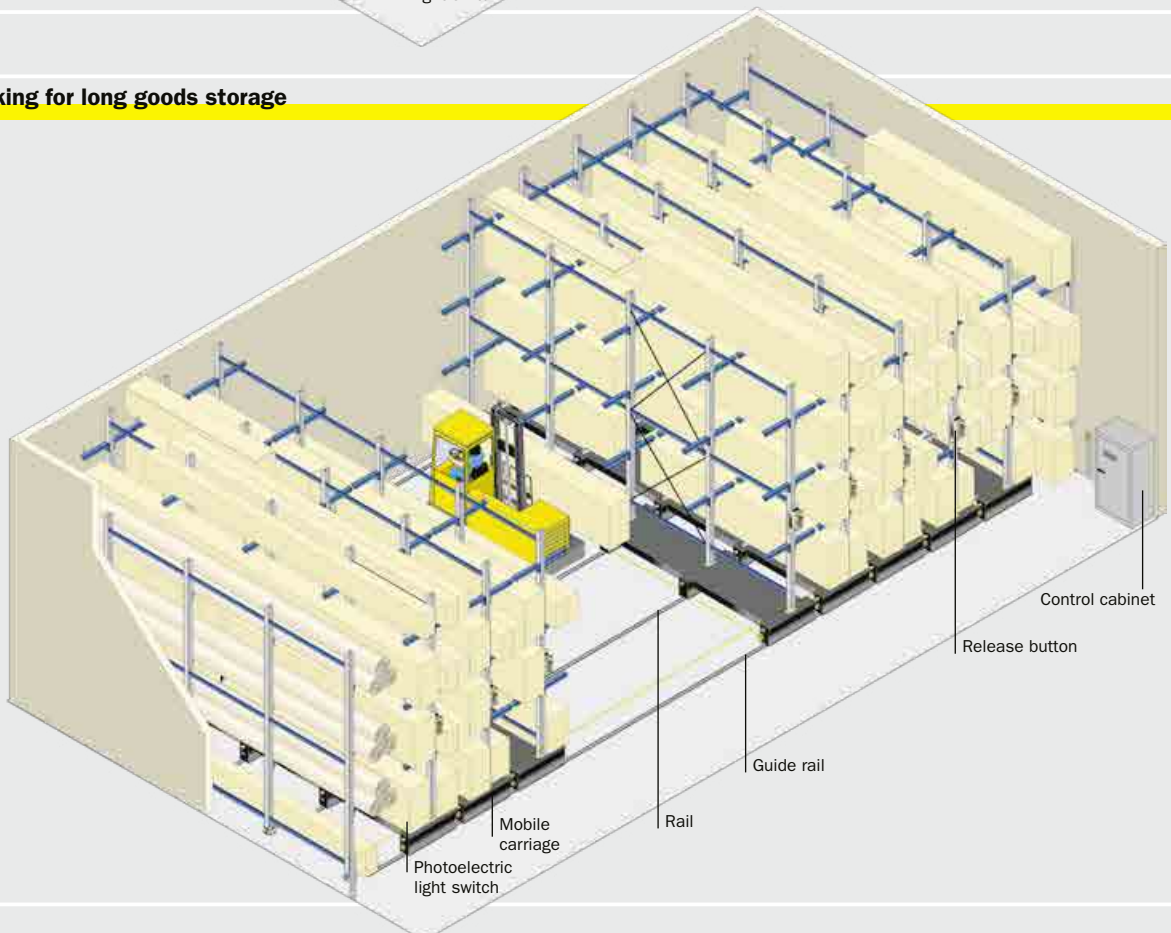

Boxes / containers

Modular shelving

Longspan racking

Pallet racking

Cantilever racking

Mezzanines / platforms

On-line shelving / KDR shelving

Semi-automated solutions

Logistics systems

Appendix

Pallet live storage racking

Pallet live storage racking systems are used as buffer storage for shipping, in production and also for incoming and outgoing goods. The racks are usually accessed using front forklifts and reach trucks. Manual lifting trolleys can also be used for the lowest level on the removal side. The storage utilizes the first-in-first-out principle (FiFo). Stored goods with an expiry date or product batches are easier to monitor. The design of the gravity roller conveyors can be

adapted to the specific goods using different roll divisions and brake rollers. The other advantages of this storage system are the optimum use of surface area and volume as well as the ability to integrate the system into the automated material flow.

Furthermore, the pallets can also be accessed on multiple stories with additional order picking levels or tunnels.



Further information

on request



Staging live storage and pushback racks

Pallet live storage

The live storage warehouse consists of gravity roller conveyors installed in a rack as live storage levels. The space it is used highly efficiently as multiple channels are positioned next to each other and the room height is optimally utilized. The storage and retrieval sides are separated. Roller conveyors provide both storage and transport functions.

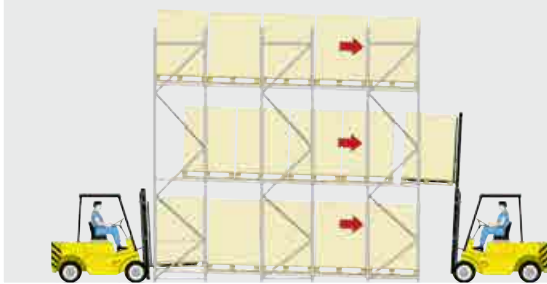

Pallet pushback racking

Pallets pushback racking is space-saving buffer storage with only one access aisle. This storage technology pushes the stored goods up the incline of the roller conveyor and into a channel with the help of a feeding device. During removal, the following pallets are braked by the removal process with the forklift. Eliminating brake rollers and separators creates a cost-effective solution. All of the articles are always accessible on the removal side of the rack. Pallet pushback racking utilizes the LiFo principle (last-in-first-out).

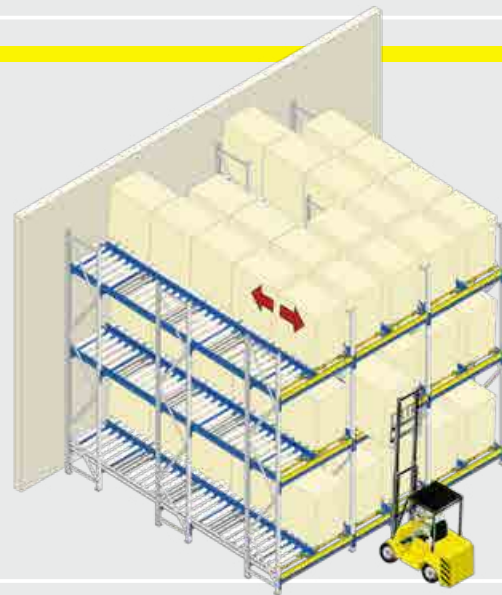
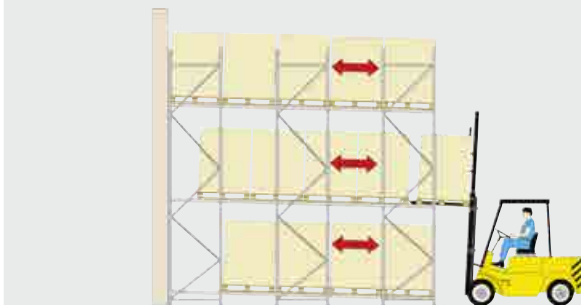

Pallet live storage rack storage with order picking tunnel

Pallet live storage racking systems are becoming an increasingly important part of warehouse logistics due to the consistent combination of buffer storage and order picking. Pallet live storage racking with order picking tunnels utilizes the FIFO principle (first-in-first-out). The resupply and order picking operations are separated and large article volumes are possible. These systems provide optimum solutions for a beverage trade or electrical equipment manufacturers.

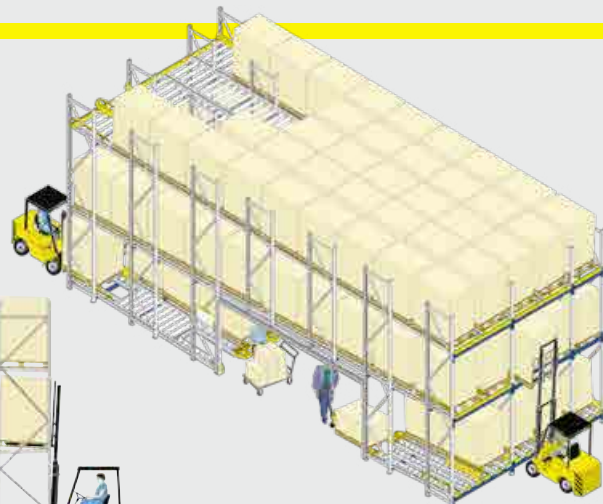
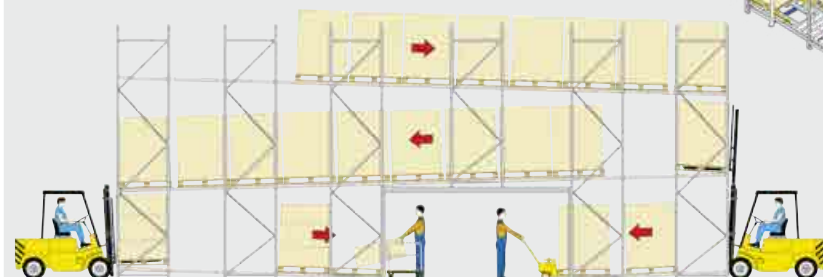

Boxes / containers

Modular shelving

Longspan racking

Pallet racking

Cantilever racking

Mezzanines / platforms

On-line shelving / KDR shelving

Semi-automated solutions

Logistics systems

Appendix

Narrow aisle high rise racking system

High rise warehouse solutions with narrow-aisle designs enable the highest storage capacity even with confined areas and restricted storage space.

SSI SCHAEFER systems have proven themselves in numerous applications. We apply our worldwide expertise and many years of experience gained through collaboration with manufacturers of floors, storage and retrieval devices, aisle protection and fire protection equipment when implementing a storage solution for our customers.

SSI SCHAEFER sees itself as a professional service provider.



i Further information

on request

High rise racking staging



Narrow aisle system with order picking trucks (man-up)

This is by far the most frequently used storage type. The advantages are:

- Operator constantly at removal height, therefore no positioning aid is required.
- Order picking from the pallet is possible.

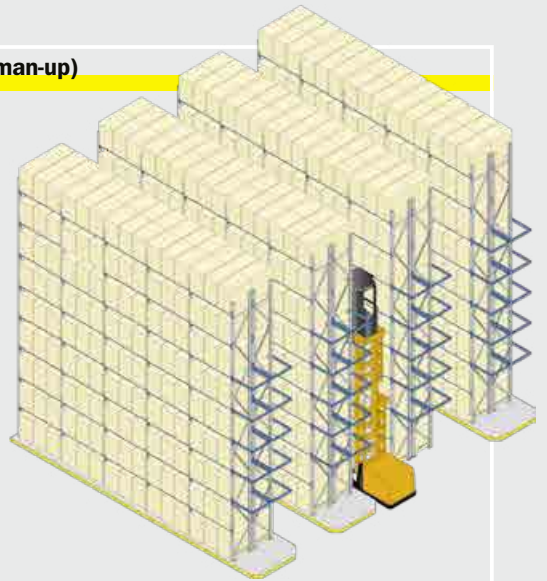

Narrow aisle system with high-bay stackers (man-down)

This type storage is used when entire loading aids need to be stored and retrieved. In contrast to man-up devices, higher racks and smaller tolerances for the floor and rack need to be observed and both horizontal and vertical positioning aids are required.

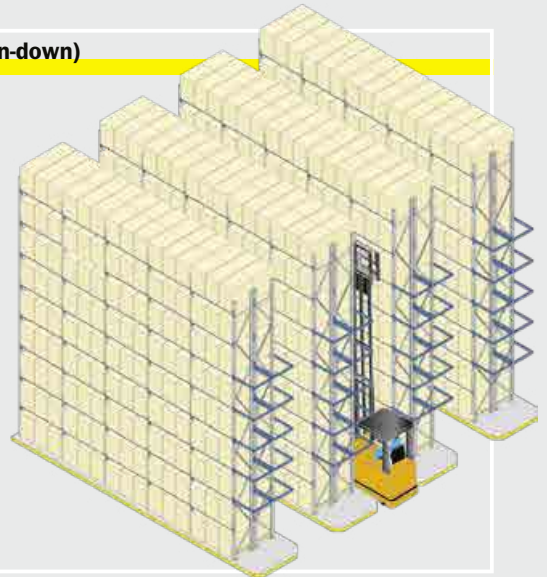

Narrow aisle system with order picking trucks (man-up) and upper guide rail

This additional upper guide rail with integrated power rail allows large rack heights (up to 19 m) and rack lengths (> 100 m) together with high traveling speeds. Compliance with very small floor and rack tolerances is an important prerequisite to ensure a perfect functioning.

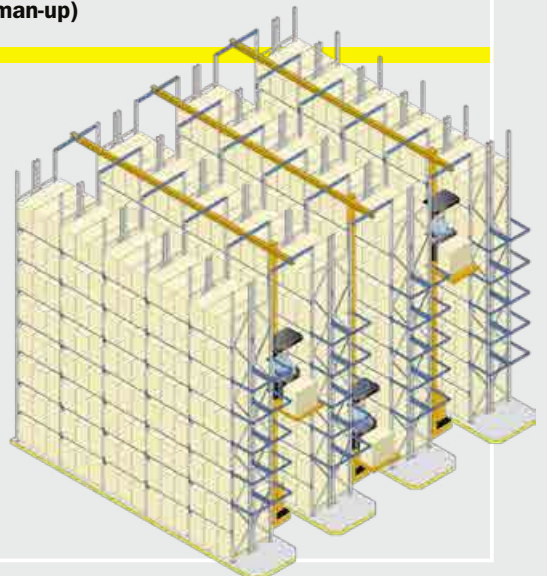

Boxes / containers

Modular shelving

Longspan racking

Pallet racking

Cantilever racking

Mezzanines / platforms

On-line shelving / KDR shelving

Semi-automated solutions

Logistics systems

Appendix